



## INSTRUCTION MANUAL

DUAL BAND FM TRANSCEIVER

# IC-2820H

This device complies with Part 15 of the FCC Rules. Operation is subject to the following two conditions: (1) this device may not cause harmful interference, and (2) this device must accept any interference received, including interference that may cause undesired operation.



**Icom Inc.**

---

## FOREWORD

---

Thank you for purchasing this Icom product. The IC-2820H DUAL BAND FM TRANSCEIVER is designed and built with Icom's superior technology and craftsmanship. With proper care, this product should provide you with years of trouble-free operation.

We want to take a couple of moments of your time to thank you for making your IC-2820H your radio of choice, and hope you agree with Icom's philosophy of "technology first." Many hours of research and development went into the design of your IC-2820H.

### ◆ FEATURES

- *Diversity reception*
- *DV (Digital Voice) with GPS operation capabilities* (Optional UT-123 is required)
- *V/V, U/U simultaneous receive capability*
- *Independent controls for both left and right receivers*
- *Separate controller for flexible installation*
- *Remote control microphone included*

---

## IMPORTANT

---

**READ ALL INSTRUCTIONS** carefully and completely before using the transceiver.

**SAVE THIS INSTRUCTION MANUAL**— This instruction manual contains important operating instructions for the IC-2820H.

---

## EXPLICIT DEFINITIONS

---

WORD	DEFINITION
⚠ <b>WARNING!</b>	Personal injury, fire hazard or electric shock may occur.
<b>CAUTION</b>	Equipment damage may occur.
<b>NOTE</b>	Recommended for optimum use. No risk of personal injury, fire or electric shock.

Icom, Icom Inc. and the ICOM logo are registered trademarks of Icom Incorporated (Japan) in the United States, the United Kingdom, Germany, France, Spain, Russia and/or other countries. All other products or brands are registered trademarks or trademarks of their respective holders.

---

## PRECAUTIONS

---

**⚠ WARNING RF EXPOSURE!** This device emits Radio Frequency (RF) energy. Extreme caution should be observed when operating this device. If you have any questions regarding RF exposure and safety standards please refer to the Federal Communications Commission Office of Engineering and Technology's report on Evaluating Compliance with FCC Guidelines for Human Radio frequency Electromagnetic Fields (OET Bulletin 65).

**⚠ WARNING! NEVER** connect the transceiver to an AC outlet. This may pose a fire hazard or result in an electric shock.

**⚠ WARNING! NEVER** operate the transceiver while driving a vehicle. Safe driving requires your full attention—anything less may result in an accident.

**NEVER** connect the transceiver to a power source of more than 16 V DC. This will damage the transceiver.

**NEVER** connect the transceiver to a power source using reverse polarity. This will damage the transceiver.

**NEVER** cut the DC power cable between the DC plug and fuse holder. If an incorrect connection is made after cutting, the transceiver may be damaged.

**NEVER** expose the transceiver to rain, snow or any liquids. The transceiver may be damaged.

**NEVER** operate or touch the transceiver with wet hands. This may result in an electric shock or damage the transceiver.

**NEVER** place the transceiver where normal operation of the vehicle may be hindered or where it could cause bodily injury.

**NEVER** let objects impede the operation of the cooling fan on the rear panel.

**DO NOT** push the PTT when not actually desiring to transmit.

**DO NOT** allow children to play with any radio equipment containing a transmitter.

During mobile operation, **DO NOT** operate the transceiver without running the vehicle's engine. When the transceiver's power is ON and your vehicle's engine is OFF, the vehicle's battery will soon become exhausted.

**AVOID** using or placing the transceiver in direct sunlight or in areas with temperatures below  $-10^{\circ}\text{C}$  or above  $+60^{\circ}\text{C}$ .

**BE CAREFUL!** The transceiver will become hot when operating it continuously for long periods.

**AVOID** setting the transceiver in a place without adequate ventilation. Heat dissipation may be affected, and the transceiver may be damaged.

**AVOID** the use of chemical agents such as benzine or alcohol when cleaning, as they can damage the transceiver's surfaces.

**USE** Icom microphones only (supplied or optional). Other manufacturer's microphones have different pin assignments and may damage the transceiver if attached.

*For USA only*

**CAUTION:** Changes or modifications to this device, not expressly approved by Icom Inc., could void your authority to operate this device under FCC regulations.

# SUPPLIED ACCESSORIES

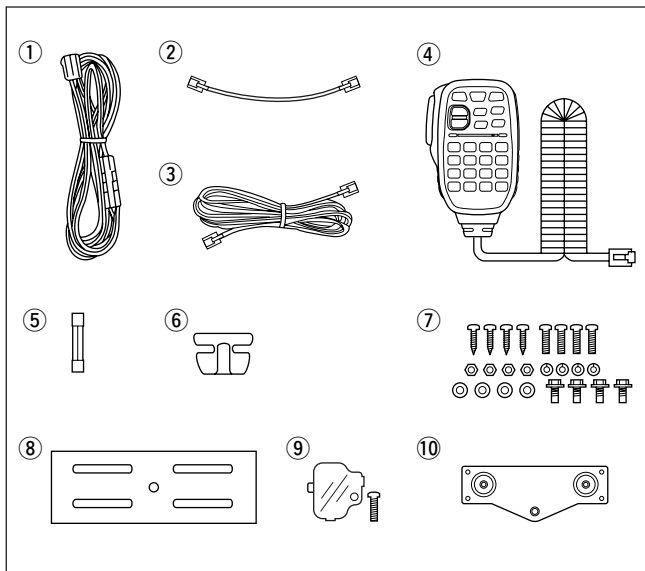

① DC power cable (3 m) .....	1
② Controller cable (10 cm <sup>†</sup> ; 3.9 in <sup>†</sup> ) .....	1
③ Separation cable (3.4 m <sup>†</sup> ; 11.2 ft <sup>†</sup> ) .....	1
④ Microphone (HM-133)* .....	1
⑤ Fuse (20 A) .....	1
⑥ Microphone hanger .....	1
⑦ Mounting screws, nuts and washers .....	1 set
⑧ Mobile mounting bracket .....	1
⑨ Microphone connector plate with screw .....	1 set
⑩ Remote controller bracket .....	1

\*HM-154 HAND MICROPHONE may be supplied with some versions.

<sup>†</sup>Approx.

---

# TABLE OF CONTENTS

---

FOREWORD .....	i
IMPORTANT .....	i
EXPLICIT DEFINITIONS .....	i
PRECAUTIONS .....	ii
SUPPLIED ACCESSORIES .....	iii
TABLE OF CONTENTS .....	iv
<b>QUICK REFERENCE GUIDE .....</b>	<b>I–XIV</b>
■ Installation .....	I
■ Your first contact .....	X
■ Repeater operation .....	XII
■ Programming memory channels.....	XIII
<b>1 PANEL DESCRIPTION .....</b>	<b>1–14</b>
■ Front panel— controller .....	1
■ Function display .....	3
■ Function guide indications .....	7
■ Main unit .....	9
■ Microphone (HM-133) .....	11
■ Microphone keypad .....	12
■ Optional microphones (HM-154).....	14
<b>2 SETTING A FREQUENCY .....</b>	<b>15–19</b>
■ Preparation .....	15
■ Using the tuning dial .....	17
■ Using the [▲]/[▼] keys .....	17
■ Using the keypad .....	17
■ Tuning step selection .....	18
■ Lock functions .....	19

<b>3 BASIC OPERATION .....</b>	<b>20–28</b>
■ Receiving .....	20
■ Transmitting .....	20
■ Selecting output power .....	21
■ Operating mode selection .....	21
■ Squelch attenuator .....	22
■ V/V, U/U simultaneous receive (Para-watch) .....	23
■ Sub band mute/busy beep .....	24
■ Monitor function .....	24
■ Single band operation .....	25
■ One-touch PTT function .....	26
■ Audio mute function .....	27
■ Band scope .....	27
<b>4 REPEATER OPERATION .....</b>	<b>29–35</b>
■ General .....	29
■ Accessing a repeater .....	30
■ Subaudible tones .....	32
■ Offset frequency .....	34
■ Auto repeater (USA/KOREA versions only) .....	35

<b>1</b>
<b>2</b>
<b>3</b>
<b>4</b>
<b>5</b>
<b>6</b>
<b>7</b>
<b>8</b>
<b>9</b>
<b>10</b>
<b>11</b>
<b>12</b>
<b>13</b>
<b>14</b>
<b>15</b>
<b>16</b>
<b>17</b>
<b>18</b>

---

# TABLE OF CONTENTS

---

<b>5 DV MODE OPERATION</b> (Optional UT-123 is required) .....	<b>36–60</b>
■ Digital mode operation .....	36
■ Call sign programming .....	36
■ Digital voice mode operation .....	39
■ About D-STAR system .....	41
■ Digital repeater operation .....	42
■ Received call sign .....	47
■ Copying the call sign .....	49
■ Break-in communication .....	51
■ Message operation .....	52
■ Automatic reply function .....	55
■ EMR communication .....	56
■ Low-speed data communication .....	57
■ DV voice memory .....	58
■ DV automatic detect .....	60
<b>6 MEMORY MODE OPERATION</b> .....	<b>61–71</b>
■ General description .....	61
■ Memory channel selection .....	61
■ Programming a memory channel .....	62
■ Memory bank selection .....	64
■ Memory bank setting .....	65
■ Programming memory/bank/scan name .....	66
■ Copying memory contents .....	68
■ Memory clearing .....	70
■ Erasing/transferring bank contents .....	71
<b>7 CALL CHANNEL OPERATION</b> .....	<b>72–73</b>
■ Call channel selection .....	72
■ Call channel copying .....	72
■ Programming a call channel .....	73
<b>8 SCAN OPERATION</b> .....	<b>74–79</b>
■ Scan types .....	74
■ Scan start/stop .....	75
■ Scan edges programming .....	76
■ Scan resume condition .....	78
■ Skip channel setting .....	79
<b>9 PRIORITY WATCH</b> .....	<b>80–81</b>
■ Priority watch types .....	80
■ Priority watch operation .....	81
<b>10 DTMF MEMORY ENCODER</b> .....	<b>82–85</b>
■ Programming a DTMF tone sequence .....	82
■ Transmitting a DTMF tone sequence .....	83
■ DTMF speed .....	85
<b>11 TONE SQUELCH AND POCKET BEEP</b> .....	<b>86–91</b>
■ Tone/DTCS squelch beep operation .....	86
■ DTCS polarity setting .....	89
■ Tone scan .....	90
■ Digital call sign/digital code squelch .....	91

<b>12 PAGER/CODE SQUELCH .....</b>	<b>92–95</b>	<b>15 OTHER FUNCTIONS .....</b>	<b>115–124</b>
■ Pager function .....	92	■ Microphone keys .....	115
■ Code programming .....	92	■ All reset .....	116
■ Pager operation .....	94	■ Partial reset .....	116
■ Code squelch .....	95	■ Data cloning .....	117
<b>13 EXTERNAL DTMF REMOTE .....</b>	<b>96–97</b>	■ Auto power OFF .....	118
<b>14 MENU SCREEN OPERATION .....</b>	<b>98–114</b>	■ Time-out timer .....	118
■ General .....	98	■ Packet operation .....	119
■ Menu list .....	98	■ Weather channel operation (USA version only) .....	123
■ Item list .....	99	<b>16 GPS/GPS-A OPERATION .....</b>	<b>125–132</b>
■ SET MODE items .....	101	■ GPS operation .....	125
■ DV SET MODE items .....	103	■ GPS-A operation .....	132
■ SCAN items .....	105	<b>17 MAINTENANCE .....</b>	<b>133–135</b>
■ DUP/TONE items .....	106	■ Troubleshooting .....	133
■ DISPLAY items .....	107	■ Fuse replacement .....	134
■ SOUND items .....	109	■ Optional UT-123 installation .....	135
■ DV GPS items .....	110	<b>18 SPECIFICATIONS AND OPTIONS .....</b>	<b>136–138</b>
■ PACKET items .....	111	■ Specifications .....	136
■ GPS SET MODE items .....	111	■ Options .....	137
■ GPS-A SET MODE items .....	113		

# QUICK REFERENCE GUIDE

## ■ Installation

### ◇ Precaution— magnets

#### △ CAUTION

Magnets are used for the controller's attachment to the main unit.

**NEVER** hold the whole unit by the controller only when carrying the transceiver. Carry the transceiver holding the main unit. If held by the controller, the main unit may drop off and may result in injury to the person carrying it or damage the transceiver.

**NEVER** attach the controller on the main unit's top cover, particularly around the internal speaker grill. It may cause the contents of the CPU and memory device could be deleted.

**NEVER** put the controller near a clock, television set (CRT type), magnetic compass and any magnetic/IC cards, credit cards, etc. It may cause the product to malfunction, and the content of the magnetic card could be deleted.

Please note that the controller may drop off when a high impact or vibration is applied.

### ◇ Installation methods

#### • *Single body installation*

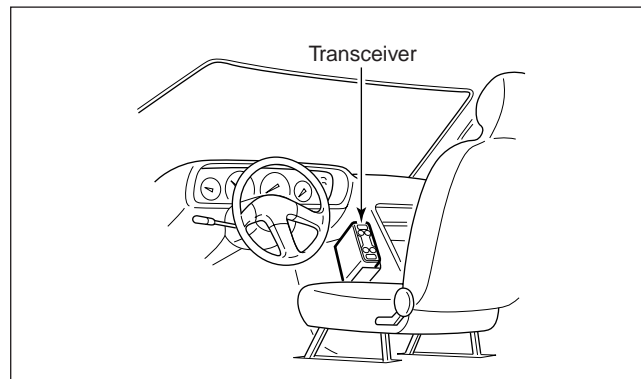

- The supplied mounting bracket can be used for the main unit installation.

• **Remote installation**

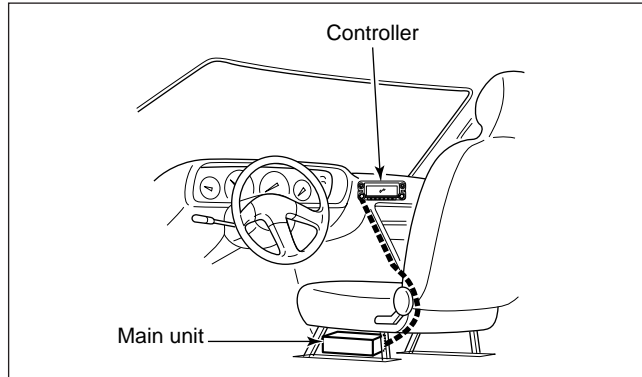

- The supplied remote controller bracket and separation cable can be used for installation.
- Optional OPC-440 MICROPHONE CABLE (5.0 m; 16.4 ft) is available to extend the microphone cable.
- Optional OPC-441 SPEAKER CABLE (5.0 m; 16.4 ft) is available to extend the speaker cable.

◇ **Location**

Select a location which can support the weight of the transceiver and does not interfere with driving. We recommend the locations shown in the diagram below.

**NEVER** place the transceiver or remote controller where normal operation of the vehicle may be hindered or where it could cause bodily injury.

**NEVER** place the transceiver or remote controller where air bag deployment may be obstructed.

**DO NOT** place the transceiver or remote controller where hot or cold air blows directly onto it.

**AVOID** placing the transceiver or remote controller in direct sunlight.

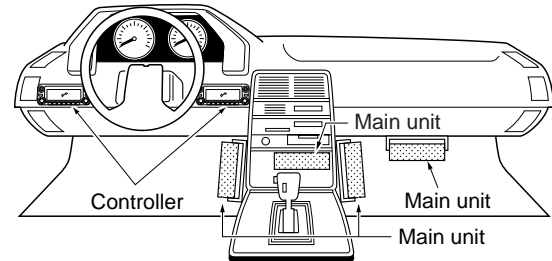

## QUICK REFERENCE GUIDE

### ◇ Using the mounting bracket

- ① Drill 4 holes where the mounting bracket is to be installed.
  - Approx. 5.5–6 mm (1/4") when using nuts; approx. 2–3 mm (1/8") when using self-tapping screws.
- ② Insert the supplied screws, nuts and washers through the mounting bracket and tighten.
- ③ Adjust the angle for your suitable position.

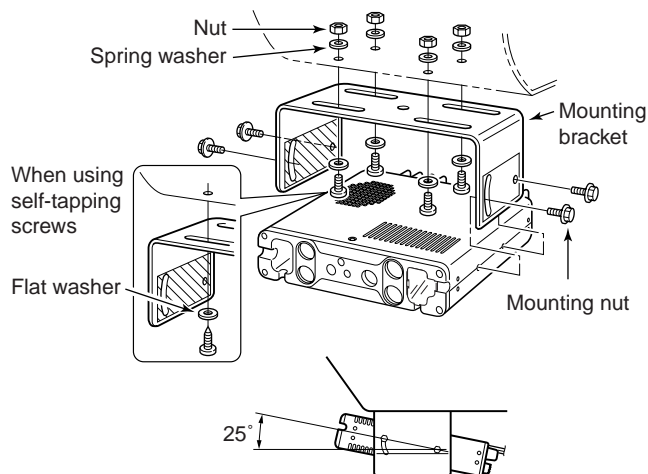

### ◇ Controller/Separation cable connection

Two connection cables, controller cable (10 cm; 3.9 in) for single body installation and separation cable (3.4 m; 11.2 ft) for remote installation, are supplied with the IC-2820H.

Connect the controller and the main unit using with the supplied connection cable as follows.

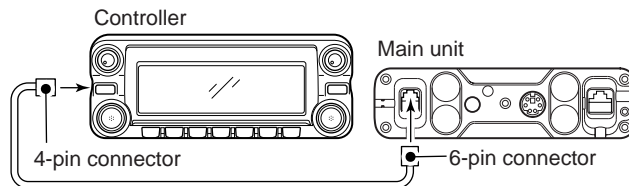

### **IMPORTANT!**— number of pin

The connectors on the ends of the connection cable have different numbers of pins - one end has 6 pins and the other end 4 pins. You should connect the 6-pin connector to the main unit, and the 4-pin connector to the controller.

◇ **Microphone connection**

A microphone connector is available on the main unit front panel. Connect the supplied microphone connector as illustrated below.

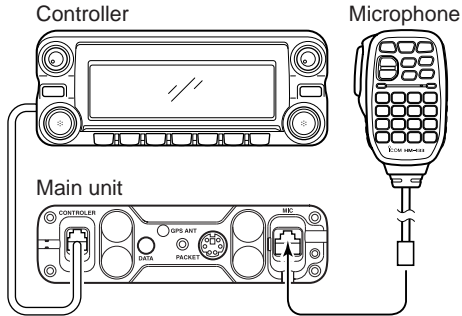

Attach the supplied microphone connector plate after the microphone connection, otherwise the controller will separate from the main unit when the microphone cable is pulled during single body installation.

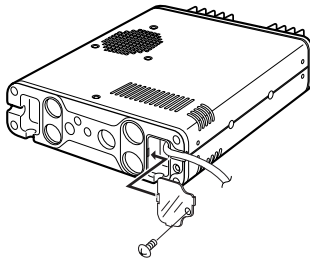

◇ **Optional GPS antenna connection**

When the optional UT-123 is installed, the GPS antenna supplied with the UT-123 can be connected. Connect the GPS antenna as below.

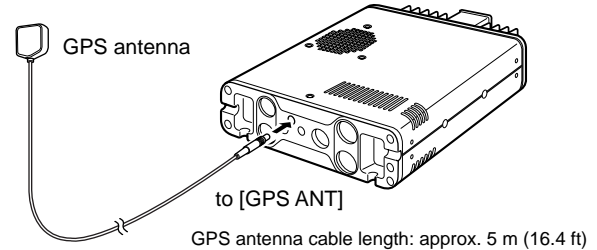

Mount the GPS antenna onto a convenient flat surface. The GPS antenna includes magnet mount base, therefore, the antenna can be mounted onto a metal roof/wall, etc.

**NOTE**

When the GPS antenna is connected, only remote installation is allowed. The GPS antenna is not weather-proof construction, therefore, **NEVER** install the antenna in outdoor.

## QUICK REFERENCE GUIDE

### ◇ Important notes when using GPS receiver

- The GPS antenna is not weather-proof construction, therefore, **NEVER** install the antenna in outdoor.
- Please do not install the GPS antenna close the TX antenna. The transmit signal may cause GPS receiver malfunction.
- The GPS signal cannot pass through the metal object. When installing GPS antenna inside a vehicle, we recommend to mount under the front or rear glass such as on the dashboard, etc. Please avoid the areas shown in the following:
  1. Do not mount where it will block the driver's view.
  2. Do not mount where the air bags could deploy.
- The Global Positioning System (GPS) is built and operated by the US Defence Department. The Department is responsible for accuracy and maintenance of the system. Any changes that the Department makes may affect the accuracy and function of the GPS system.
- When GPS receiver is activated, please do not cover the GPS antenna with any object.
- The GPS receiver may not work if used in the following locations:
  1. Tunnels or high-rise buildings
  2. Underground parking lot
  3. Under a bridge or viaduct
  4. In remote forested areas
  5. Under bad weather condition (rainy or cloudy day)

### ◇ Controller's attachment

You can attach the controller of the IC-2820H by one of 2 methods.

#### • Example 1

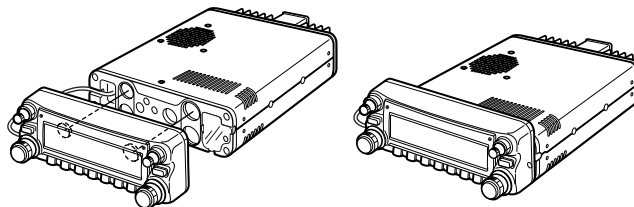

#### • Example 2

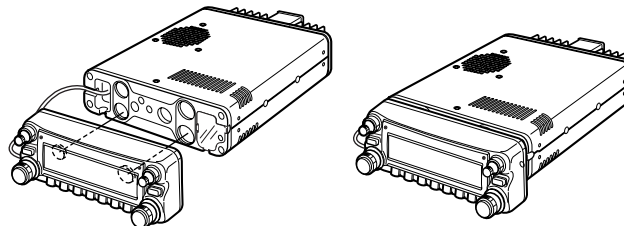

◇ **Remote installation**

The supplied remote controller bracket is used for remote installation.

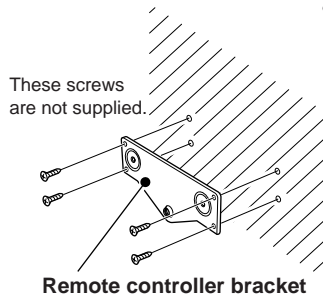

- Attach the remote controller bracket onto a flat surface using with 4 self-tapping screws (2.6 mm(d)), or double-sticky tape, etc., as at left, then attach remote controller to the bracket.

**When installing into your vehicle**

- ① Remove two screws and magnets from the remote controller.
- ② Attach the supplied remote controller bracket as below.

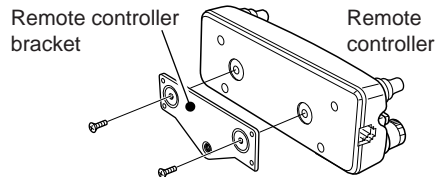

- ③ Attach the remote controller on to the optional MB-65 as below.

Adjust the viewing angle for maximum visibility of the function display.

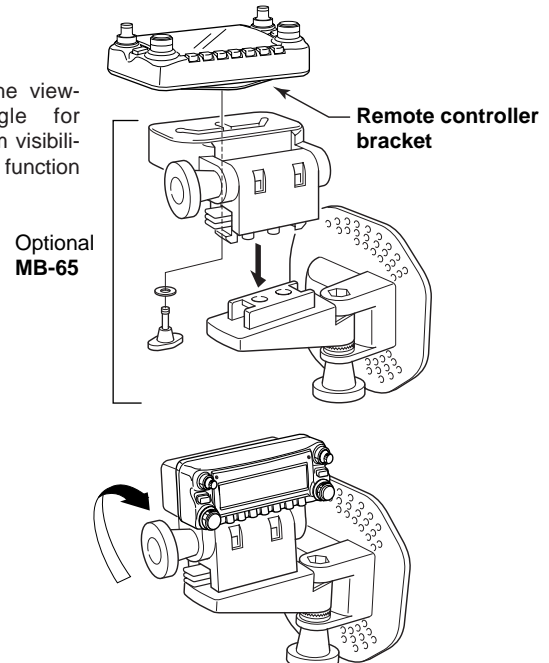

## QUICK REFERENCE GUIDE

### ◇ Battery connection

- ⚠ **WARNING NEVER** remove the fuse holders from the DC power cable.
- **NEVER** connect the transceiver directly to a 24 V battery.
- **DO NOT** use the cigarette lighter socket for power connections. (See p. 10 for details)

Use a rubber grommet when passing the DC power cable through a metal plate to prevent a short circuit.

### • CONNECTING TO A DC POWER SOURCE

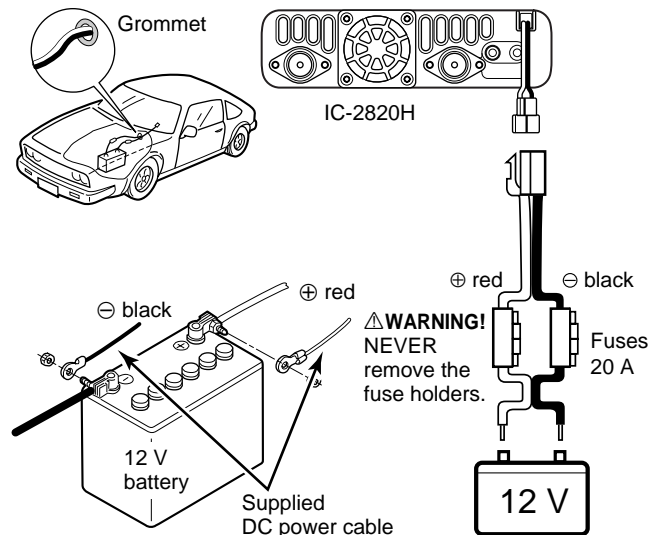

**NOTE:**  
Use terminals for the cable connections.



◇ **DC power supply connection**

Use a 13.8 V DC power supply with at least 15 A capacity.

Make sure the ground terminal of the DC power supply is grounded.

• **CONNECTING TO A DC POWER SUPPLY**

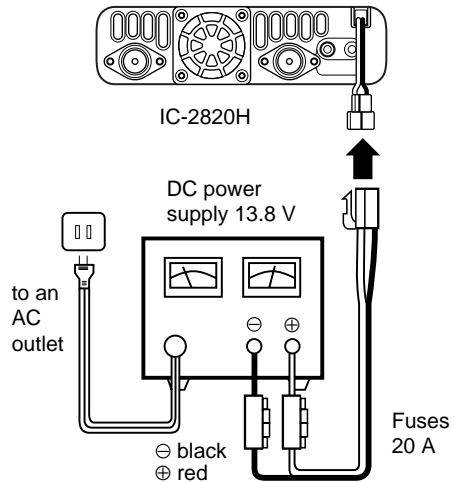

See p. 134 for fuse replacement.

## QUICK REFERENCE GUIDE

### ◇ Antenna installation

#### • Antenna location

To obtain maximum performance from the transceiver, select a high-quality antenna and mount it in a good location. It is not necessary to use radials on a magnetic mount (“mag mount”) antenna.

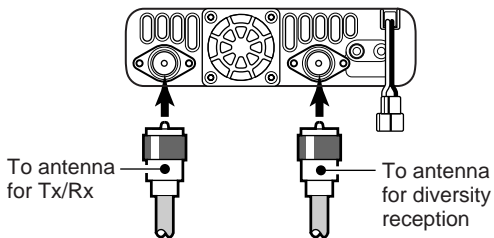
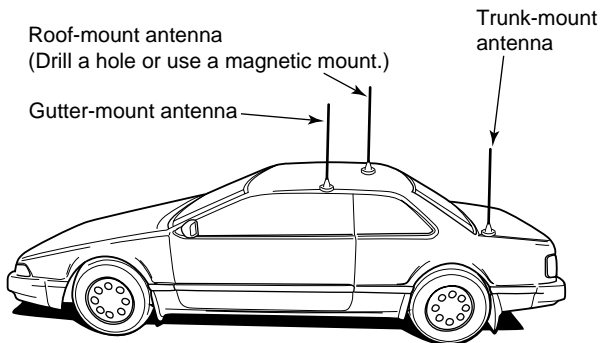

#### • Antenna connector

The antenna uses a PL-259 connector.

#### • PL-259 CONNECTOR

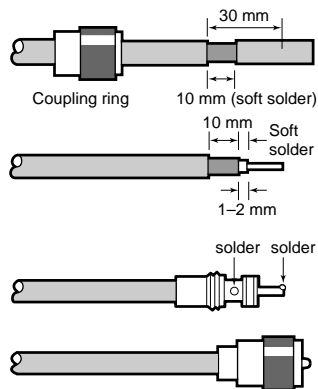

① Slide the coupling ring down. Strip the cable jacket and tin.

② Strip the cable as shown at left. Soft solder the center conductor.

③ Slide the connector body on and solder it.

④ Screw the coupling ring onto the connector body.  
(10 mm  $\approx$  3/8 in)

/// **NOTE:** There are many publications covering proper antennas and their installation. Check with your local dealer for more information and recommendations.

## ■ Your first contact

Now that you have your IC-2820H installed in your car or shack, you are probably anxious to get on the air. We would like to take you through a few basic operation steps to make your first time “On The Air” an enjoyable experience.

### 1. Turning ON the transceiver

Before powering up your IC-2820H, you may want to make sure the audio volume and squelch level controls are set in 9–10 o'clock positions.

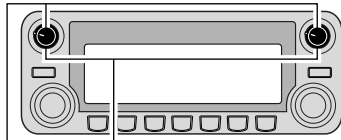

Set both [VOL] and [SQL] controls to 9–10 o'clock positions.

Although you have purchased a brand new transceiver, some settings may be changed from the factory defaults because of the Quality Control (QC) process. Resetting the CPU is necessary to start from factory default.

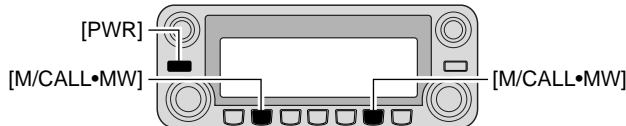

While pushing both [M/CALL•MW], turn power ON.

➔ While pushing both band's [M/CALL•MW] keys, push and hold [PWR] for 1 sec. to reset the CPU.

### 2. Selecting the main band

The IC-2820H displays 2 frequencies on the left and right bands simultaneously. However, transmission, some keys and microphone operation apply only to the main band.

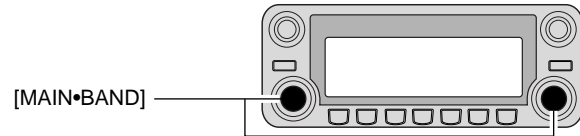

➔ Push the desired band's (left or right) [MAIN•BAND] to select the main band.

- “[MAIN]” appears for the main band.

### Using the HM-133

You can select the main band from the HM-133.



Push **BAND**

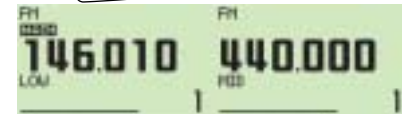

Push **BAND** again

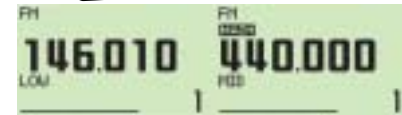

## QUICK REFERENCE GUIDE

### 3. Selecting the operating frequency band

The IC-2820H can use 2 m or 70 cm on either the left or right band. The operating band can be exchanged between them, and using the same bands, V/V and U/U, is also possible..

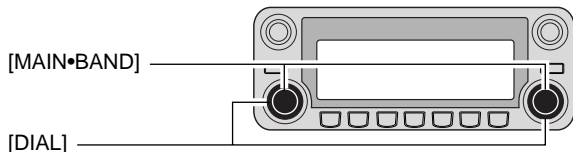

Frequency band initial is displayed.

- ➔ Push and hold the desired band's (left or right) **[MAIN•BAND]** for 1 sec. then rotate the appropriate band's **[DIAL]**.
  - Push **[MAIN•BAND]** momentarily to return to frequency indication.

### 4. Tune the frequency

The tuning dial will allow you to dial in the frequency you want to use. Pages 17 and 18 will instruct you on how to set the tuning speed.

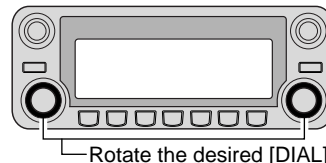

### Using the HM-133

You can directly enter the frequency with the HM-133 keypad for the main band.

**[EXAMPLE]:** Setting frequency to 145.3625 MHz.



Push **VFO/LOCK**



Push **T-OFF ENT C**

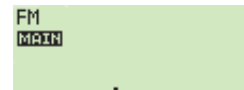

Push **BANK MON1**

**DTCS HIGH 4**

**DTCS MID 5**



**PTT-M Prio 3**

**DTMF LOW 6**

Push **T-SCAN SCAN 2**



## ■ Repeater operation

### 1. Setting duplex

Push the desired band's **[MAIN•BAND]** to select the main band. Push **[DUP•MONI]** once or twice to select minus duplex or plus duplex.

- The USA version has an auto repeater function, therefore, setting duplex is not required.

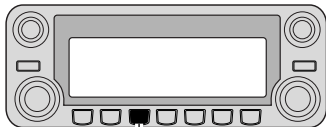

Push **[DUP•MONI]**.



### 2. Repeater tone

Push **[TONE•DTMF]** several times until "TONE" appears, if the repeater requires a subaudible tone to be accessed.

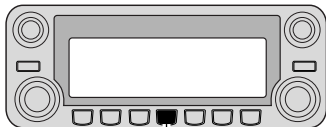

Push **[TONE•DTMF]**.



### Using the HM-133

Plus or minus duplex selection and the repeater tone setting can be made easily via the HM-133.

Push **[DUP- 7(TONE)]** for minus duplex; **[DUP+ 8(TSQL ((•)))]** for plus duplex selection, push **[FUNC]** then **[DUP- 7(TONE)]** to turn the repeater tone ON.



Push **[TONE DUP- 7]**

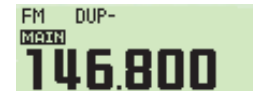

Push **[TSQL ((•)) DUP+ 8]**

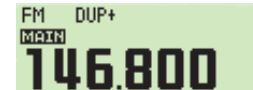

Push **[FUNC]**, then **[TONE DUP- 7]**



### ■ Programming memory channels

The IC-2820H has a total of 522 memory channels (including 20 scan edge and 2 call channels) for storing often used operating frequency, repeater settings, etc.

Any memory channel can be recalled on either the left or right band.

#### 1. Setting a frequency

In VFO mode, set the desired operating frequency with repeater, tone and tuning steps, etc.

- Push the desired band's **[V/MHz•SCAN]** to select VFO.
- Rotate the same band's **[DIAL]** to set the desired frequency.
  - Set other data, such as repeater tone, duplex information, tuning step), if desired.

#### 2. Selecting a memory channel

Push and hold the same band's **[M/CALL•MW]** for 1 sec., then rotate the same band's **[DIAL]** to select the desired memory channel.

- "MR" indicator and memory channel number blink.

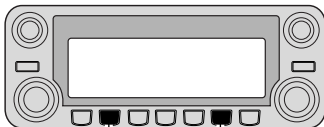

Push **[M/CALL•MW]** for 1 sec.



#### 3. Writing a memory channel

Push and hold **[S.MW](M/CALL•MW)** (Left band's) for 1 sec. to program.

- 3 beeps sound
- Return to VFO mode automatically after programming.
- Memory channel number automatically increases when continuing to push **[M/CALL•MW]** after programming.

---

### Using the HM-133

- ① Push [MR/CALL] to select memory mode.
- ② Push [ENT C(T-OFF)] first, then enter the desired memory channel via the keypad.
- ③ Push [VFO/LOCK] to select VFO mode, then set the desired operating frequency, including offset direction, tone settings, etc.
  - ➔ Push [VFO/LOCK] to select VFO.
  - ➔ Push [ENT C(T-OFF)] first, then enter the desired operating frequency via the keypad.
    - Set other data, such as repeater tone, duplex information, tuning step, if necessary.
- ④ Push [FUNC] then push and hold [CLR A(MW)] for 1 sec. to program.

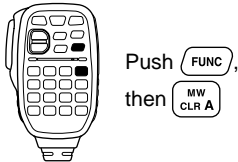

- 3 beeps sound
  - Memory channel number automatically increases when continuing to push [CLR A(MW)] after programming.
-

# 1

## PANEL DESCRIPTION

### ■ Front panel— controller

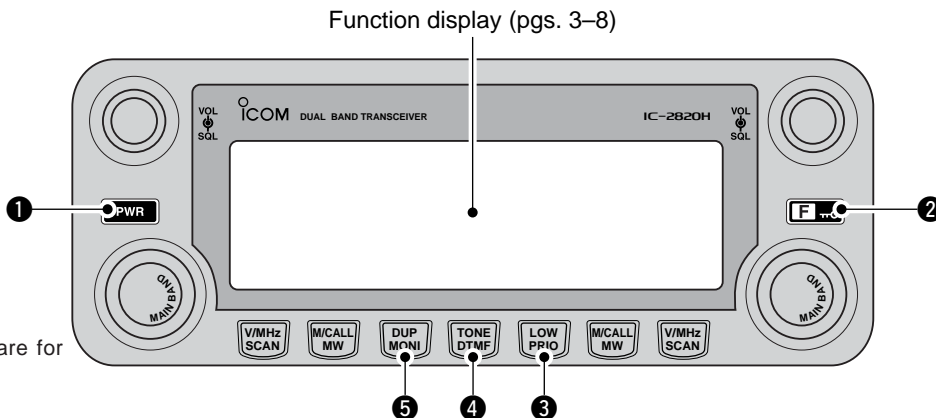

\*The keys 2 to 5 are for the MAIN band only.

#### 1 POWER KEY [PWR]

➔ Push and hold for 1 sec. to turn power ON and OFF.

#### 2 FUNCTION•LOCK KEY [F-trk]

- ➔ Push to display the function guide. (p. 7)
- ➔ Push and hold for 1 sec. to turn the lock function ON and OFF. (p. 19)

#### 3 OUTPUT POWER•PRIORITY KEY [LOW•PRIO]

- ➔ Each push changes the output power selection. (p. 21)
- ➔ Push and hold for 1 sec. to start a priority watch. (p. 81)

#### 4 TONE•DTMF KEY [TONE•DTMF]

- ➔ Each push selects a tone function. (pgs. 30, 86, 91)
  - TONE, TSQ L, TSQ L-R, DTCS, DTCS-R, DSQ L, \*DSQ L, \*CSQ L, \*CSQ L\* or tone function OFF can be selected.
- \*Available only when optional UT-123 is installed.
- ➔ Push and hold for 1 sec. to enter DTMF set mode. (p. 82)

#### 5 DUPLEX•MONITOR KEY [DUP•MONI]

- ➔ Push to select DUP-, DUP+ and simplex (no indicator visible) operation. (p. 30)
- ➔ Push and hold for 1 sec. to turn the monitor function ON and OFF. (p. 24)

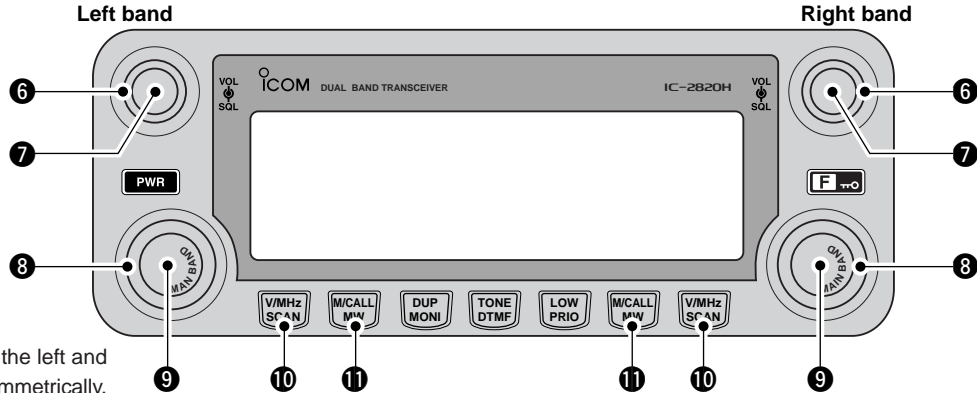

\*The same controls for both the left and right bands are arranged symmetrically.

**6 SQUELCH CONTROL [SQL]**

- Varies the squelch level for left and right band. (p. 20)
- The RF attenuator activates and increases the attenuation when rotated clockwise at and beyond the center position. (p. 22)

**7 VOLUME CONTROL [VOL]** (p. 20)

Adjusts the audio level for left or right band.

**8 TUNING DIAL [DIAL]**

Selects the operating frequency (p. 17), memory channel (p. 61), the setting of the set mode item and the scanning direction (p. 75) for left or right band.

**9 MAIN•BAND KEY [MAIN•BAND]**

- ➔ Push to select the main band. (p. 15)
- ➔ Push and hold for 1 sec. to enter band selection mode. (p. 15)

**10 VFO/MHz TUNING•SCAN KEY [V/MHz•SCAN]**

- ➔ Push to select between VFO mode and 1 MHz (or 10 MHz for some versions) tuning. (p. 17)
- ➔ Push and hold for 1 sec. to enter scan type selection mode. (p. 75)
  - Cancels a scan when pushed during scan.

**11 MEMORY/CALL•MEMORY WRITE KEY [M/CALL•MW]**

- ➔ Push to select and toggle memory, call and weather channel\* modes. (pgs. 61, 72, 123)
  - \*Weather channels are available for USA version only.
- ➔ Push and hold for 1 sec. to enter select memory write mode for memory channel programming. (pgs. 62, 73, 76)

# 1 PANEL DESCRIPTION

## ■ Function display

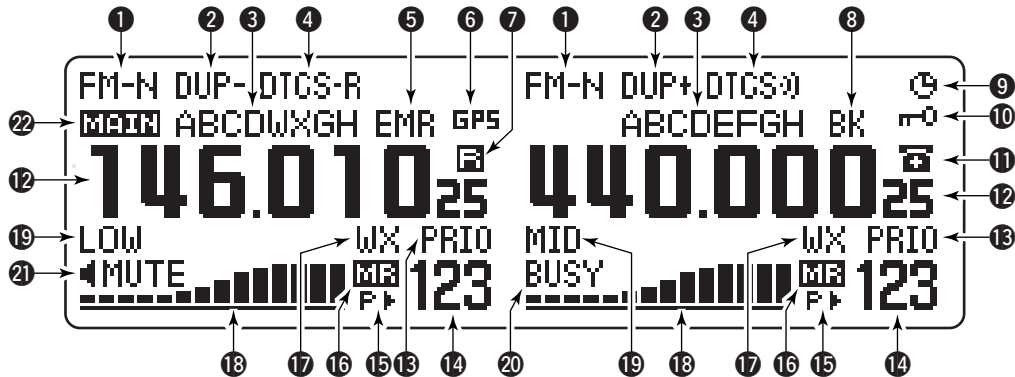

\*The same indications for both the left and right bands are arranged.

### ① OPERATING MODE INDICATOR (p. 21)

Shows the selected operating mode.

- FM, FM-N, AM, AM-N and DV\* are available, depending on operating band.

\*Available only when the optional UT-123 is installed.

### ② DUPLEX INDICATORS (p. 30)

“DUP+” appears when plus duplex, “DUP-” appears when minus duplex (repeater) operation is selected.

### ③ NAME INDICATOR

During memory mode operation, the programmed memory or memory bank name is displayed.

### ④ TONE INDICATOR

↳ During FM mode operation:

- “TONE” appears while the repeater tone is in use. (p. 30)
- “TSQL” appears while the tone squelch function is in use. (p. 86)
- “TSQL-R” appears while the reverse tone squelch function is in use. (p. 87)
- “DTCS” appears while the DTCS squelch function is in use. (p. 86)
- “DTCS-R” appears while the reverse DTCS squelch function is in use. (p. 87)

- During DV\* (Digital) mode operation:
  - “DSQL” appears while the digital call sign squelch function is in use. (p. 91)
  - “CSQL” appears while the digital code squelch function is in use. (p. 91)
- “” appears with the “TSQL,” “DTCS,” “DSQL”\* or “CSQL”\* indicator while the pocket beep function is in use. (pgs. 86, 91)

\*Available only when the optional UT-123 is installed.

**5 EMR MODE INDICATOR**

- “EMR” appears when the EMR mode\* operation is in use. (p. 56)
- “L” appears when packet loss occurs during the low-speed data communication\*.

\*Available only when the optional UT-123 is installed.

**6 GPS INDICATOR** (p. 126)

- Appears while GPS function\* is in use.
- \*Available only when the optional UT-123 is installed.

**7 SUB BAND REMOTE CONTROL INDICATOR** (p. 96)

- Appears when the sub band remote control function is in use.

**8 BREAK-IN INDICATOR** (p. 51)

- Appears when the break-in\* operation is in use.
- \*Available only when the optional UT-123 is installed.

**9 AUTO POWER OFF INDICATOR** (p. 118)

- Appears when the auto power OFF function is in use.

**10 KEY LOCK INDICATOR** (p. 19)

- Appears when the key lock function is activated.

**11 DTMF INDICATOR** (p. 83)

- Appears while automatic DTMF transmission is in use.

**12 FREQUENCY READOUT**

- Shows the operating frequency, set mode contents, etc.
  - Frequency decimal point blinks while scanning. (p. 75)

**13 PRIORITY INDICATOR** (p. 81)

- Appears while priority watch is activated, blinks while priority watch is paused.

**14 MEMORY CHANNEL NUMBER INDICATORS**

- Shows the selected memory channel number. (p. 61)
- Shows the selected bank initial. (p. 64)
- “C” appears when the call channel is selected. (p. 72)

**15 SKIP INDICATOR** (p. 79)

- “▶” appears when the displayed memory channel is specified as a skip channel.
- “P▶” appears when the displayed frequency is specified as a program skip frequency.

**16 MEMORY INDICATOR** (p. 61)

- Appears when memory mode is selected.

**17 WEATHER ALERT INDICATOR** (p. 123)

- “WX” appears when the weather alert function is in use.
- \*Available with the USA version only.

# 1 PANEL DESCRIPTION

## ■ Function display— continued

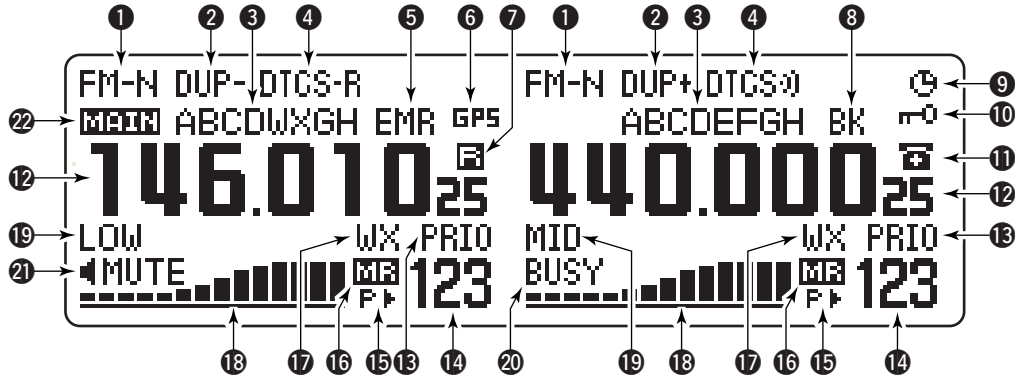

\*The same indications for both the left and right bands are arranged.

### 18 S/R/F INDICATORS

- Shows the relative signal strength while receiving signals. (p. 20)
- Shows the output power level while transmitting. (p. 21)

### 19 OUTPUT POWER INDICATORS

“LOW” appears when low output power; “MID” appears when middle output power, “HI” appears when high output power is selected.

### 20 BUSY INDICATOR

- Appears when a signal is being received or the squelch is open. (p. 20)
- Blinks while the monitor function is activated. (p. 24)

### 21 AUDIO MUTE INDICATOR

Appears when the audio mute (p. 27) or sub band mute (p. 24) function is in use.

### 22 MAIN INDICATOR (p. 15)

Indicates the main band for transmit and function control.

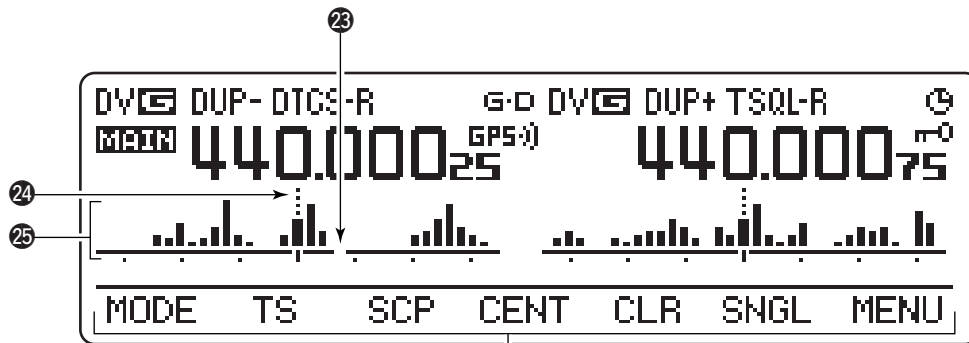

Function guide indications (pgs. 7, 8)

**23 FREQUENCY MARKER** (p. 27)

Gap shows the selected frequency in the band scope.

**24 CENTER FREQUENCY MARKER**

Dotted line shows the center frequency of the band scope.

**25 BAND SCOPE INDICATOR**

When the band scope function is in use, shows the band conditions.

## ■ Function guide indications

The function guide indications allow you to simply using a wide variety of functions.

### ◇ Function guide

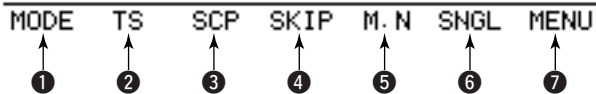

#### ① MODE KEY [MODE](V/MHz•SCAN) (p. 21)

Push to select an operating mode from FM, FM-N, AM, AM-N and DV\* in main band.

\*Available only when the optional UT-123 is installed.

#### ② TUNING STEP KEY [TS](M/CALL•MW) (p. 18)

Push to display the tuning step selection mode.

- 5.0,\* 6.25,\* 10, 12.5, 15,\* 20, 25, 30 and 50 kHz steps are available.

\*Not selectable in 900 MHz band.

#### ③ BAND SCOPE KEY [SCP](DUP•MONI) (p. 28)

➤ Push to display the simple band scope and make a single sweep of the band.

➤ Push and hold for 1 sec. to display the simple band scope and sweep continuously.

- Push [SCP](DUP•MONI) momentarily to cancel the sweep.

#### ④ SCAN SKIP KEY [SKIP](TONE•DTMF) (p. 79)

In memory mode, push to select the scan skip condition for the selected memory channel.

- “▶” appears when memory skip, “P▶” appears when program skip selection.

#### ⑤ MEMORY NAME INDICATION KEY [M.N](LOW•PRIO)

(p. 67)

Push to select the memory name indication.

- Memory name, frequency and OFF selections are available.

#### ⑥ SINGLE WATCH KEY [SNGL](M/CALL•MW) (p. 25)

Push to select the single band operation mode.

- Push [DUAL](M/CALL•MW)(for right band) to select the dual-watch mode.

#### ⑦ MENU MODE KEY [MENU](V/MHz•SCAN) (p. 98)

Push to select the MENU screen indication.

◇ **Function guide 2**

/// The function guide 2 indicators appear only when the optional UT-123 is installed and DV mode is selected.

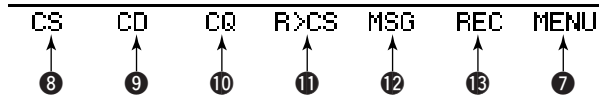

- 8 CALL SIGN SELECT KEY [CS](V/MHz•SCAN)** (p. 39)  
Push to display the call sign selection screen.
- 9 RECEIVED CALL SIGN RECORD KEY [CD](M/CALL•MW)** (p. 47)  
Push to display the received call sign record screen.
- 10 CQ KEY [CQ](DUP•MONI)** (p. 40)  
Push to set "CQCQCQ" as the station call sign for the call.
- 11 CALL SIGN SET KEY [R>CS](TONE•DTMF)** (p. 48)  
Push to copy and set the previously received station call sign as the station call sign for making a call.
- 12 DV MESSAGE KEY [MSG](LOW•PRIO)** (p. 53)  
Push to display the DV message screen.
- 13 VOICE MEMORY KEY [REC](V/MHz•SCAN)** (p. 58)  
Push to display the DV voice memory record screen.

◇ **Function guide 3**

/// The function guide 3 indications appear only when the optional UT-123 is installed and GPS function is set to ON.

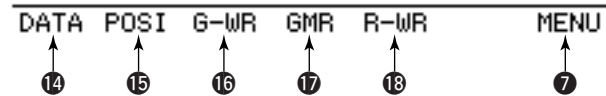

- 14 DATA KEY [DATA](V/MHz•SCAN)** (p. 127)  
Push to toggle GPS data communication ON and OFF.  
• "G•D" appears when the GPS data from GPS receiver is selected.
- 15 POSITION INFORMATION KEY [POSI](M/CALL•MW)** (p. 127)  
Push to toggle your own position information, target station information screen and frequency indication.
- 16 GPS DATA STORE KEY [G-WR](DUP•MONI)** (p. 127)  
Push and hold for 1 sec. to store your own current position information.
- 17 GPS MEMORY RECALL KEY [GMR](TONE•DTMF)** (p. 130)  
Push to cause the GPS memory screen to display the stored position information.
- 18 RECEIVED POSITION DATA STORE KEY [R-WR](LOW•PRIO)** (p. 129)  
Push and hold for 1 sec. to store the received position information.

# 1 PANEL DESCRIPTION

## ■ Main unit

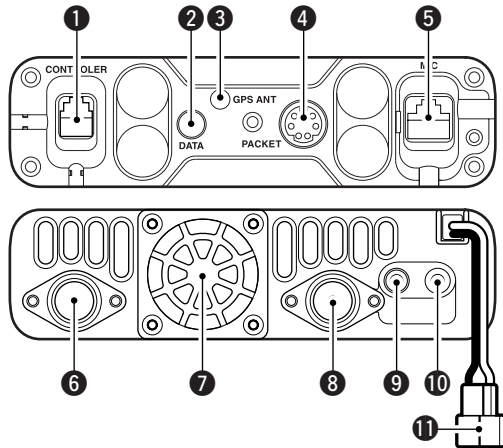

**1 CONTROLLER CONNECTOR [CONTROLLER]** (p. III)  
Connects the controller unit with the supplied controller or separation cable.

**2 DATA JACK [DATA]** (p. 57)  
Connect to a PC via the optional data communication cable OPC-1529R for data cloning with the optional cloning software, CS-2820, or low-speed data communication in DV\* mode operation.

\*Available only when the optional UT-123 is installed.

**3 GPS ANTENNA CONNECTOR [GPS ANT]** (p. IV)  
When the optional digital unit, UT-123, is installed, connects the GPS antenna supplied with the optional UT-123.

**4 PACKET JACK [PACKET]** (pgs. 120, 121)  
Connects a TNC (Terminal Node Controller), etc. for data communications. The receiver can support 1200/9600 bps packet communication (AFSK/GMSK).

**5 MICROPHONE CONNECTOR [MIC]** (p. IV)  
Connects the supplied or an optional microphone.

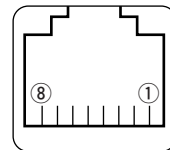

- ① +8 V DC output (Max. 10 mA)
- ② Channel up/down
- ③ 8 V control IN
- ④ PTT
- ⑤ GND (microphone ground)
- ⑥ MIC (microphone input)
- ⑦ GND
- ⑧ Data IN

**6 ANTENNA CONNECTOR [ANT1 TX/RX]** (p. IX)  
Connects a 50  $\Omega$  antenna with a PL-259 connector and a 50  $\Omega$  coaxial cable for transmission and reception.

**7 COOLING FAN**  
Rotates while transmitting.  
Also rotates while receiving depending on the setting in set mode. (p. 101)

**8 ANTENNA CONNECTOR [ANT2 RX]** (p. IX)

Connects a 50 Ω antenna with a PL-259 connector and a 50 Ω coaxial cable for diversity reception.

**9 EXTERNAL SPEAKER JACK 1 [SP-1]**

Connects an 8 Ω speaker. Outputs audio from both left and right bands when no external speaker is connected to [SP-2]. See the table at right for details.

- Audio output power is more than 2.4 W.

**10 EXTERNAL SPEAKER JACK 2 [SP-2]**

Connects an 8 Ω speaker. Outputs right band's audio only.

- Audio output power is more than 2.4 W.

**11 POWER RECEPTACLE [DC13.8V]**

Accepts 13.8 V DC ±15% with the supplied DC power cable.

**NOTE: DO NOT** use a cigarette lighter socket as a power source when operating in a vehicle. The plug may cause voltage drops and ignition noise may be superimposed onto transmit or receive audio.

**ANTENNA INFORMATION**

For radio communications, the antenna is of critical importance, to maximize your output power and receiver sensitivity. The transceiver accepts a 50 Ω antenna and a Voltage Standing Wave Ratio (VSWR) of 1.5:1 or less. High SWR values not only may damage the transceiver but also lead to TVI or BCI problems.

**• Speaker information**

Connected speaker	Left band audio	Right band audio
No external speakers	Internal speaker (mixed audio)	
[SP-1] only	External speaker (mixed audio)	
[SP-2] only	Internal speaker	External speaker
2 external speakers	External speaker via [SP-1]	External speaker via [SP-2]

# 1 PANEL DESCRIPTION

## ■ Microphone (HM-133\*)

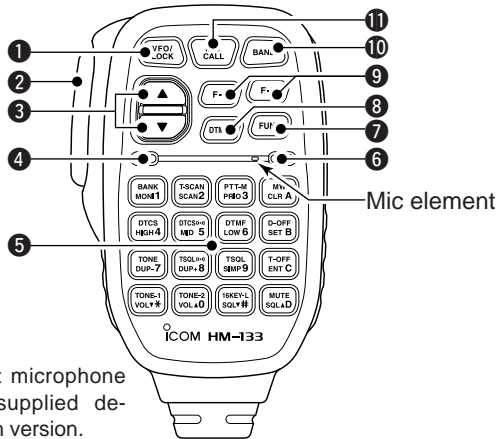

\*A different microphone may be supplied depending on version.

### 1 VFO/LOCK KEY [VFO/LOCK]

- ➔ Push to select VFO mode. (p. 16)
- ➔ Push and hold for 1 sec. to turn the lock function ON and OFF. (p. 19)

### 2 PTT SWITCH

- ➔ Push and hold to transmit; release to receive.
- ➔ Switches between transmitting and receiving while the one-touch PTT function is in use. (p. 26)

### 3 UP/DOWN KEYS [▲]/[▼]

- ➔ Push either key to change operating frequency, memory channel, set mode setting, etc. (pgs. 17, 61, 98)

- ➔ Push and hold either key for 1 sec. to start scanning. (p. 75)

### 4 ACTIVITY INDICATOR

- ➔ Lights red while any key, except [FUNC] and [DTMF-S], is pushed, or while transmitting.
- ➔ Lights green while the one-touch PTT function is in use.

### 5 KEYPAD (pgs. 12, 13)

### 6 FUNCTION INDICATOR

- ➔ Lights orange while [FUNC] is activated—indicates the secondary function of keys can be accessed.
- ➔ Lights green when [DTMF-S] is activated—DTMF signals can be transmitted with the keypad.

### 7 2nd FUNCTION KEY [FUNC]

### 8 DTMF SELECT KEY [DTMF-S] (p. 84)

### 9 FUNCTION KEYS [F-1]/[F-2] (p. 115)

- ➔ Program and recall your desired transceiver configuration.

### 10 BAND KEY [BAND] (p. 15)

- ➔ Push to select main band between left and right bands.













### 11 MEMORY/CALL KEY [MR/CALL]

- ➔ Push to select memory mode. (p. 61)
- ➔ Push and hold for 1 sec. to select call channel. (p. 72)









#### ✓ Important!

All keys on the microphone function for the main band only.

## ■ Microphone keypad

KEY	FUNCTION	SECONDARY FUNCTION (  +key)	OTHER FUNCTIONS
	Switches between opening and closing the squelch. (p. 24)	In VFO mode enters operating band selection. In memory mode enters bank selection. (p. 64)	After pushing  : Transmits the appropriate DTMF code. (pgs. 33, 84) When the DTMF memory encoder is activated, push [0] to [9] to transmit the appropriate DTMF memory contents . (p. 84)
	Starts and stops scanning. (p. 75)	Starts and stops tone scanning. (p. 90)	
	Starts and stops priority watch. (p. 81)	Turns the one-touch PTT function ON and OFF. (p. 26)	
	Selects high output power. (p. 21)	Turns the DTCS squelch ON. (p. 86)	
	Selects mid. output power. (p. 21)	Turns the DTCS pocket beep function ON. (p. 86)	
	Selects low output power. (p. 21)	Turns the DTMF memory encoder function ON. (p. 83)	
	Selects minus duplex operation. (p. 31)	Turns the subaudible tone encoder ON. (p. 31)	
	Selects plus duplex operation. (p. 31)	Turns the CTCSS pocket beep function ON. (p. 86)	
	Selects simplex operation. (p. 31)	Turns the tone squelch function ON. (p. 86)	
	Increases audio output level. (p. 20)	Sends a 1750 Hz tone signal while pushing and holding. (p. 33)	

# 1 PANEL DESCRIPTION

KEY	FUNCTION	SECONDARY FUNCTION (  +key)	OTHER FUNCTIONS
	<ul style="list-style-type: none"> <li>➤ Cancels frequency entry. (p. 17)</li> <li>➤ Cancels the scan or priority watch. (pgs. 75, 81)</li> <li>➤ Exit set mode. (p. 98)</li> </ul>	<ul style="list-style-type: none"> <li>➤ Stores the set frequency, etc., into the selected memory channel when pushed and held. (p. 63)</li> <li>➤ Advances the memory channel number when continuously pushed after programming is completed. (p. 63)</li> </ul>	After pushing  : Transmits the appropriate DTMF code. (pgs. 33, 84)
	<ul style="list-style-type: none"> <li>➤ Enters MENU screen. (p. 98)</li> <li>➤ Enters selected set mode. (p. 98)</li> <li>➤ Enters programmable condition after selecting a set mode item. (p. 98)</li> </ul>	DTMF memory encoder function OFF. (p. 83)	
	<ul style="list-style-type: none"> <li>➤ Sets the keypad for numeral input. (p. 17)</li> <li>➤ Returns to the previous indication after entering set mode. (p. 98)</li> </ul>	Turns the subaudible tone encoder, pocket beep or CTCSS/DTCS tone squelch OFF. (pgs. 31, 86)	
	Adjusts the squelch level increments. (p. 20)	Mutes the audio. (p. 27) • Mute function is released when any operation is performed.	
	Decreases audio output level. (p. 20)	Sends a 1750 Hz tone signal for 0.5 sec. (p. 33)	
	Adjusts the squelch level decrement. (p. 20)	Locks the digit keys on the keypad (including the A to D, # and * keys. (p. 19)	

## ■ Optional Microphone (HM-154)

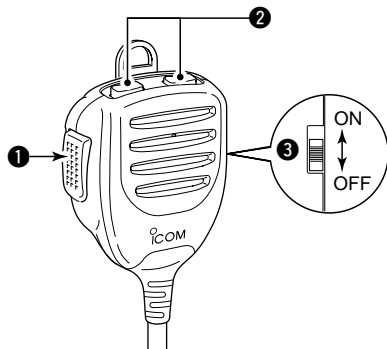

### ① PTT SWITCH

Push and hold to transmit; release to receive.

### ② UP/DOWN KEYS [UP]/[DN]

- ➔ Push either key to change operating frequency, memory channel, set mode setting, etc. (pgs. 17, 61, 98)
- ➔ Push and hold either key for 1 sec. to start scanning. (p. 75)

### ③ UP/DN LOCK SWITCH

Slide to toggle [UP]/[DN] keys function ON and OFF.

## ■ Preparation

### ◇ Turning power ON/OFF



- ➔ Push and hold **[PWR]** for 1 sec. to turn power ON and OFF.

### ◇ MAIN band

The IC-2820H can receive 144 MHz and 440(430) MHz band signals simultaneously. To change or activate any of the functions or to change frequency via the microphone, you must designate one band as the main band. The transceiver transmits a signal on the main band only.

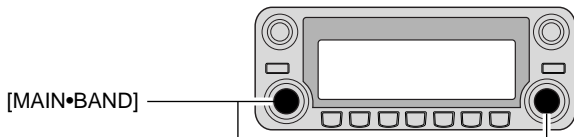

- ➔ Push the desired band's **[MAIN•BAND]** to select the main band.
  - "**MAIN**" indicates the main band.



- ➔ Push **[BAND]** to toggle the main band between left and right bands.

### ◇ Operating frequency band selection

In the default condition, or after resetting the CPU, 2 m band is assigned to the left band, 70 cm band is assigned to the right band. However, the 2 m band can also be assigned into the right, and 70 cm band can also be assigned into the left band.

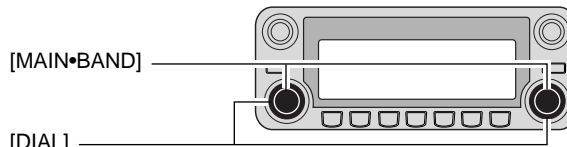

Frequency band initial is displayed.

- ① Push and hold the desired band's **[MAIN•BAND]** for 1 sec.
  - Frequency band initial appears.
- ② Rotate the same band's **[DIAL]** to select the desired frequency band.
  - Pushing **[▲]/[▼]** on the microphone also selects the band.
- ③ Push the **[MAIN•BAND]** to return to frequency indication in the selected frequency band.



Note that in this manual, sections beginning with a microphone icon (as at left), designate operation via the HM-133 microphone.



- 1 Push [BAND] to select main band.
- 2 Push and hold [BAND] for 1 sec. to enter frequency band selection.
  - The frequency band is displayed.
- 3 Push [▲]/[▼] to select the desired frequency band.
- 4 Push [CLR A(MW)] (or [BAND]) to exit the condition, and return to frequency indication.



✓ **About extra frequency bands**  
 — **USA and General versions only**

In addition to the 2 m and 70 cm ham bands, the IC-2820H USA and General versions have extra frequency bands for each left and right bands as follow.

See the specifications for the available frequency bands for details.

Frequency band initial*	Left band	Right band
127	✓	✓
136	✓	✓
146	✓	✓
222	✓	—
375	✓	✓
440	✓	✓
500	✓	✓
900	—	✓

\*The frequency band initials are default indication only. Once the operating frequency is set in the band, the initial indication will be changed.  
 ✓: Available, —: Not available

◇ **VFO and memory modes**

The transceiver has 2 basic operating modes: VFO mode and memory mode. Select VFO mode first to set an operating frequency.

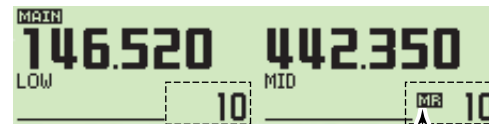
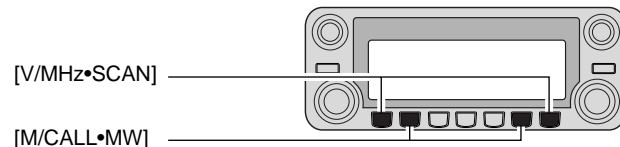

VFO mode is selected. "MR" indicator appears when memory mode is selected.

- Push the desired band's [V/MHz•SCAN] to select VFO mode.
  - When VFO mode is already selected, the digits to the right of the 10 MHz or 1 MHz digits will disappear depending on version. In this case, push [V/MHz•SCAN] again (or twice depending on version).
- Push [M/CALL•MW] to select memory mode.
  - "MR" indicator appears when memory mode is selected.



- Push [VFO/LOCK] to select VFO mode.
- Push [MR/CALL] to select memory mode.
  - The microphone controls the main band only. Push [BAND] to toggle the main band, then push [VFO/LOCK] or [MR/CALL], if necessary.

## 2 SETTING A FREQUENCY

### ■ Using the tuning dial

- ① Rotate the desired band's **[DIAL]** to set the frequency.
  - If VFO mode is not selected, push the same band's **[V/MHz•SCAN]** to select VFO mode.
  - The frequency changes in the selected tuning steps. (p. 18)

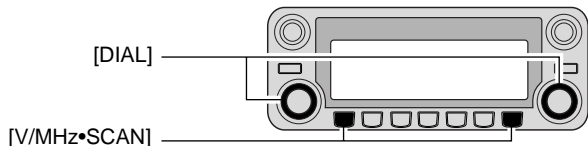

- ② To change the frequency in 1 MHz (10 MHz for some versions) steps, push **[V/MHz•SCAN]**, then rotate **[DIAL]**.
  - Pushing and holding **[V/MHz•SCAN]** for 1 sec. starts scan function. If scan starts, push **[V/MHz•SCAN]** again to cancel it.

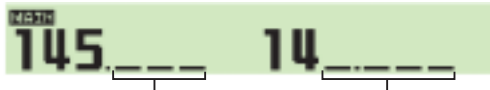

While 1 MHz tuning step is selected, the digit below 100kHz disappear.

While 10 MHz tuning step is selected, the digit below 1 MHz disappear.

### ■ Using the **[▲]/[▼]** keys



- Push **[▲]** or **[▼]** to select the desired frequency.
- Push **[BAND]** to select the desired band (left or right) as the main band in advance.
  - Pushing and holding **[▲]/[▼]** for 1 sec. activates a scan. If scan starts, push **[▲]/[▼]** or **[CLR A(MW)]** to cancel it.

### ■ Using the keypad

The frequency can be directly set via numeral keys on the microphone.



- ① Push **[BAND]** to select the desired band (left or right) as the main band.
  - Push **[VFO/LOCK]** to select VFO mode, if necessary.
- ② Push **[ENT C(T-OFF)]** to activate the keypad for digit input.
- ③ Push 6 keys to input a frequency.
  - When a digit is mistakenly input, push **[ENT C(T-OFF)]** to clear the input, then repeat input from the 1st digit.
  - Pushing **[CLR A(MW)]** clears input digits and retrieves the frequency.

**[EXAMPLE]:** Setting frequency to 145.3625 MHz.

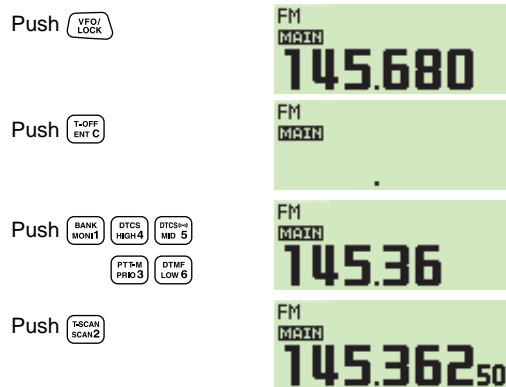

## ■ Tuning step selection

Tuning steps are the minimum frequency change increments when you rotate **[DIAL]** or push **[▲]/[▼]** on the microphone. Independent tuning steps for the left and right bands, as well as each frequency band can be set for individual tuning convenience. The following tuning steps are available.

- 5 kHz\*
- 6.25 kHz\*
- 10 kHz
- 12.5 kHz
- 15 kHz\*
- 20 kHz
- 25 kHz
- 30 kHz
- 50 kHz

\*Not selectable in 900 MHz band.

**NOTE:** For convenience, select a tuning step that matches the frequency intervals of repeaters in your area.

- ① Push the desired band's **[MAIN•BAND]** to select the main band.
  - Push the same band's **[VMHz•SCAN]** to select VFO mode, if necessary.
- ② Push **[F•** to display the function guide.

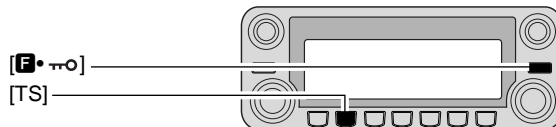

- ③ Push **[TS](M/CALL•MW)** (Left band's) to enter tuning step set mode.

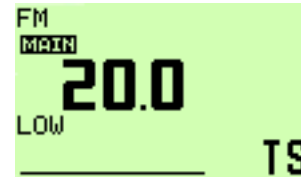

- ④ Rotate the same band's **[DIAL]** to select the desired tuning step.
- ⑤ Push **[F•** to exit tuning step set mode.

## 2 SETTING A FREQUENCY

### ■ Lock functions

To prevent accidental frequency changes and unnecessary function access, use the lock function. The transceiver has 2 different lock functions.

#### ◇ Frequency lock

This function locks dials and keys electronically and can be used together with the microphone lock function.

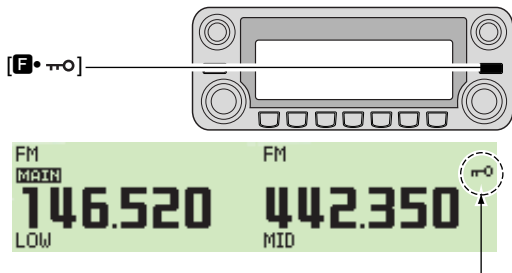

"M" appears while the lock function is activated.

➔ Push and hold [F•M] for 1 sec. to turn the lock function ON and OFF.

- [PTT], [DUP•MONI] (monitor function only), [VOL], [SQL] and [MAIN•BAND] (main band selection only) can be used while the channel lock function is in use. Also, TONE-1, TONE-2, DTMF tones or DTMF memory contents can be transmitted from the microphone.



➔ Push and hold [VFO/LOCK] for 1 sec. to turn the lock function ON and OFF.

#### ◇ Microphone keypad lock

This function locks the microphone keypad.



➔ Push [FUNC] then [SQL▼ D(16KEY-L)] to turn the microphone keypad lock function ON and OFF.

- [PTT], [VFO/LOCK], [MR/CALL], [BAND], [▲], [▼], [F-1], [F-2], [DTMF-S] and [FUNC] on the microphone can be used.
- All keys on the transceiver can be used.
- The keypad lock function is released when the power is turned OFF then ON again.

## ■ Receiving

- ① Set the audio level for the main band.
  - ➔ Push the desired band's **[MAIN•BAND]**.
  - ➔ Push and hold **[DUP•MONI]** for 1 sec. to open the squelch.
  - ➔ Rotate the main band's **[VOL]** to adjust the audio level.
  - ➔ Push the **[DUP•MONI]** to close the squelch.
- ② Set the squelch level.
  - ➔ Rotate the main band's **[SQL]** fully counterclockwise in advance, then rotate the **[SQL]** clockwise until the noise just disappears.
    - When interference due to strong signals is received, rotate **[SQL]** clockwise past 12 o'clock for attenuator operation. (p. 22)
- ③ Set the operating frequency in the main band. (pgs. 15–17)
- ④ When receiving a signal on the selected frequency, squelch opens and the transceiver emits audio.



Appears when receiving a signal.

- “BUSY” appears and the S/R/F indicator shows the relative signal strength for the received signal.

### ✓CONVENIENT!



The main band's audio and squelch level can also be adjusted with **[VOL▲(TONE-1)]**/**[VOL▼0(TONE-2)]** and **[SQL▲D(MUTE)]**/**[SQL▼#(16KEY-L)]**, respectively.

- “VOL” for audio or “SQL” for squelch appears during set.

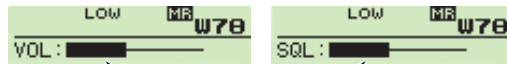

Show set level

## ■ Transmitting

**CAUTION:** Transmitting without an antenna may damage the transceiver.

**NOTE:** To prevent interference, listen on the channel before transmitting by pushing and holding **[DUP•MONI]** for 1 sec., or **[MONI 1(BANK)]** on the microphone.

- ① Select the main band. (p. 15)
- ② Set the operating frequency. (pgs. 15–17)
  - Select output power if desired. See section at right for details.
- ③ Push and hold **[PTT]** to transmit.
  - “**TX**” appears.
  - The S/R/F indicator shows the output power selection.
  - A one-touch PTT function is available. See p. 26 for details.
  - “**MUTE**” appears on the sub band screen according to the selected frequency band.
- ④ Speak into the microphone using your normal voice level.
  - DO NOT hold the microphone too close to your mouth or speak too loudly. This may distort the signal.
- ⑤ Release **[PTT]** to return to receive.

### **IMPORTANT!** (for 50 W transmission):



The IC-2820H is equipped with protection circuits to protect the power amplifier circuit from high temperature. When the transceiver temperature becomes extremely high, the transceiver reduces transmit output power to 5 W (approx.) automatically.

### 3 BASIC OPERATION

## ■ Selecting output power

The transceiver has 3 output power levels to suit your operating requirements. Low output powers during short-distance communications may reduce the possibility of interference to other stations and will reduce current consumption.

➔ Push **[LOW•PRIO]** several times to select the output power.

S/R/F INDICATOR	POWER OUTPUT	
	VHF/UHF	Taiwan
High: 	50 W/50 W	25 W
Mid: 	15 W*/15 W*	15 W*
Low: 	5 W*/5 W*	5 W*

\*approx.

• The output power can be changed while transmitting.

The microphone can also be used to select output power.



➔ Push **[HIGH 4(DTCS)]** for high output power; **[MID 5(DTCS (··))]** for middle output power; and **[LOW 6(DTMF)]** for low output power.



• The output power can be changed via the microphone during receive only.



## ■ Operating mode selection

Operating modes are determined by the modulation of the radio signals. The transceiver has total 5 operating modes (FM, FM-N, AM, AM-N and DV\* modes). The mode selection is stored independently for each band and memory channel.

Typically, AM mode is used for the air band (118–136.995 MHz), and receive is only available.

- ① Push **[F•T•O]** to display the function guide.
- ② Push **[MODE](V/MHz•SCAN)** (Left band's) several times to select the desired operating mode from FM, FM-N, AM, AM-N and DV\* in main band.

\*Available only when the optional UT-123 is installed.



[MODE]

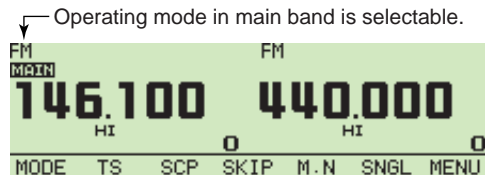

## ■ Squelch attenuator

The transceiver has an RF attenuator related to the squelch level setting. Approx. 10 dB attenuation is obtained at maximum setting.

The squelch attenuator allows you to set the minimum signal level needed to open the squelch. The attenuator function can be deactivated in set mode.

- ➔ Rotate **[SQL]** clockwise past the 13 o'clock position to activate the squelch attenuator.
  - Attenuation level can be adjusted up to 10 dB (approx.) between 13 o'clock and fully clockwise position.

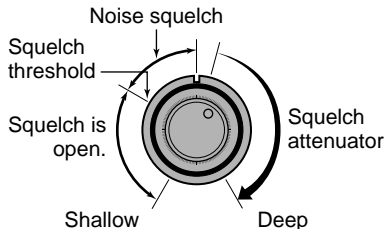

**NOTE:** The squelch attenuator functions even when the monitor function is in use. Thus it is recommended to set the **[SQL]** control between the 10 and 13 o'clock positions when using the monitor function.

### ◇ Squelch attenuator setting

- ① Push **[F•→○]** to display the function guide.
- ② Push **[MENU](V/MHz•SCAN)** (Right band's) to enter MENU screen.

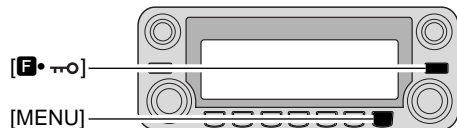

- ③ Rotate **[DIAL]** to select "SET MODE," then push **[MAIN•BAND]** to enter set mode.
- ④ Rotate **[DIAL]** to select "AUTO ATT" then push **[MAIN•BAND]**.
- ⑤ Rotate **[DIAL]** to turn the squelch attenuator function ON and OFF, then push **[MAIN•BAND]**
  - Select "OFF" to deactivate the squelch attenuator function.

MENU	SQL DELAY	SHORT
	MIC SENS LEVEL	HIGH
SET MODE	AUTO ATT	ON
	ALC	OFF
09/14	DIVERSITY	OFF
		BACK

- ⑥ Push **[BACK](V/MHz•SCAN)** (Right band's) twice to return to frequency indication.

### 3 BASIC OPERATION

## ■ V/V, U/U simultaneous receive (Para-watch)

The IC-2820H can simultaneously receive two signals on the same band, such as 144 MHz band, using the para-watch function.

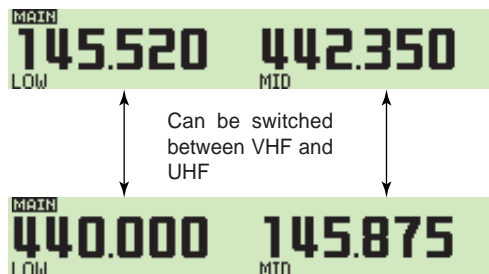

[Example]

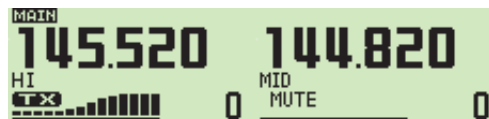

- ① Push and hold either the left or right band's **[MAIN•BAND]** for 1 sec. to select the frequency band selecting condition.
- ② Rotate the same band's **[DIAL]** to select the desired frequency band.
- ③ Push the **[MAIN•BAND]** to return to frequency indication.
- ④ Set the desired frequency.
- ⑤ Repeat the steps ① to ④ for the other band (left or right).

To activate the para-watch function from the HM-133, enter the desired frequencies for each the left and right bands using the direct frequency input capability via the keypad; or perform the following operation.



- ① Push **[BAND]** to select the desired band (left or right) as the main band.
  - Push **[VFO/LOCK]** to select VFO mode, if necessary.
- ② Push **[ENT C(T-OFF)]** to activate the keypad for digit input.
- ③ Push 6 keys to input a frequency.
  - When a digit is mistakenly input, push **[ENT C(T-OFF)]** to clear the input, then repeat input from the 1st digit.
- ④ Push **[VFO/LOCK]** to change main band, then repeat the steps ① to ③ for the other band.

#### NOTE:

- Memory channels are common for the left and right band.
- Transmitting during the para-watch operation is possible. However, the sub band's reception is deactivated during transmit as shown in the example at left.
- DV mode receiving is available only one band.

## ■ Sub band mute/busy beep

The sub band mute function automatically cuts out sub band audio signals when both main and sub band signals are received simultaneously.

While operating on the main band, a beep sounds to inform you that a signal was received on the sub band.

- ① Push **[F••••]** to display the function guide.
- ② Push **[MENU](V/MHz•SCAN)** (Right band's) to enter MENU screen.
- ③ Rotate **[DIAL]** to select "SOUNDS" then push **[MAIN•BAND]**.
- ④ Rotate **[DIAL]** to select "SUB BAND MUTE" or "SUB BAND BEEP" then push **[MAIN•BAND]**.
- ⑤ Rotate **[DIAL]** to turn the sub band mute or sub band beep function ON and OFF then push **[MAIN•BAND]**.
- ⑥ Push **[BACK](V/MHz•SCAN)** (Right band's) twice to exit set mode.
- ⑦ When a signal is received on MAIN band, "MUTE" appears as below.

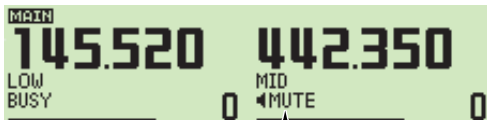

Appears when a signal is received on MAIN band.

## ■ Monitor function

This function is used to listen to weak signals without disturbing the squelch setting.

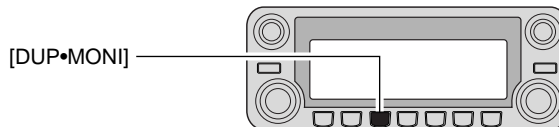

- ➔ After pushing **[MAIN•BAND]**, push and hold **[DUP•MONI]** for 1 sec. to open the squelch.
  - "BUSY" blinks.
  - Push **[DUP•MONI]** again to cancel the function.

- ➔ Push **[MONI 1(BANK)]** to open the squelch.
  - Push **[BAND]** to select the desired band (left or right) as the main band in advance.
  - Push **[MONI 1(BANK)]** again to cancel the function.

**NOTE:** When the **[SQL]** adjustment is set too far clockwise, (12–5 o'clock position) the squelch attenuator is activated. To monitor weak signals on the operating frequency, deactivate the squelch attenuator function. See page 22 for details.

## ■ Single band operation

### ◇ Single band/Dualwatch operation

Dualwatch operation monitors two frequencies simultaneously. The IC-2820H has two independent receiver circuits: left band, and right band (available frequencies, operating mode and functions are different depending on bands).

Single band operation is useful when only one frequency is being watched.

- ① Push **[F••••]** to display the function guide.
- ② Push **[SNGL](M/CALL•MW)** (Right band's) to select the single band operation mode.
  - Both left and right band's **[DIAL]**, **[MAIN•BAND]**, **[VOL]**, **[SQL]**, **[V/MHz•SCAN]** and **[M/CALL•MW]** can be used for operation.



- ③ Push **[F••••]** to display the function guide, then push **[DUAL](M/CALL•MW)** (Right band's) to return to dualwatch operation mode.

### ◇ Diversity operation

Diversity receiving compares the receiving signal strength from two different antennas, [ANT1 TX/RX] and [ANT2 RX], and automatically selects the strongest signal. This feature is useful when you are listening in a moving vehicle or the transmitting station itself is moving. Diversity receiving is available on the 127 MHz, 136 MHz, 146 MHz, 375 MHz, 440 MHz and 500 MHz bands on FM, FM-N and DV (optional) only.

- ① Push **[F••••]** to display the function guide.
- ② Push **[MENU](V/MHz•SCAN)** (Right band's) to enter MENU screen.
- ③ Rotate **[DIAL]** to select "SET MODE" then push **[MAIN•BAND]** to enter set mode.
- ④ Rotate **[DIAL]** to select "DIVERSITY" then push **[MAIN•BAND]**.
- ⑤ Rotate **[DIAL]** to select ON, then push **[MAIN•BAND]**.

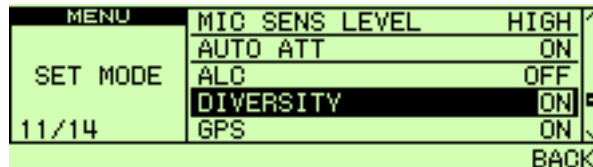

- ⑥ Push **[BACK](V/MHz•SCAN)** (Right band's) twice to return to frequency indication.

When diversity operation is in use, connect the same type antenna to both [ANT1] and [ANT2 RX].

During single band operation with the diversity function ON, the diversity indicator appears as below.



Diversity indicator appears.

 While [ANT2 RX] is selected;

 While [ANT1 TX/RX] is selected;

 When a frequency band that the diversity reception is inhibited is selected.

With the squelch open in FM mode while receiving a weak signal, diversity receiving does not work properly.

## One-touch PTT function

The PTT switch can be operated as a one-touch PTT switch (each push toggles between transmit/receive). Using this function you can transmit without pushing and holding the PTT switch.

To prevent accidental, continuous transmissions with this function, the transceiver has a time-out timer. See p. 101 for details.



- 1 Push [FUNC] then [PRIO 3(PTT-M)] to turn the one-touch PTT function ON.
  - The activity indicator lights green.
- 2 Push [PTT] to transmit and push again to receive.
  - A beep sounds when transmission is started and a long beep sounds when returning to receive.
- 3 Push [FUNC] then [PRIO 3(PTT-M)] to turn the one-touch PTT function OFF.
  - The activity indicator goes out.

### 3 BASIC OPERATION

## ■ Audio mute function

This function temporarily mutes the audio without disturbing the volume setting. (microphone only)



➔ Push [FUNC] then [SQL▲ D(MUTE)] to mute audio signals.

- The “ MUTE” indicators appear.
- Push [CLR A(MW)] (or any other key) to cancel the function.



“ MUTE” indicators appear

## ■ Band scope

The band scope function allows you to visually check a specified frequency range around the center frequency.

/// **About the sweep steps:** The specified tuning step in each frequency band (in VFO mode) or programmed tuning step (in memory mode) is used during sweep.

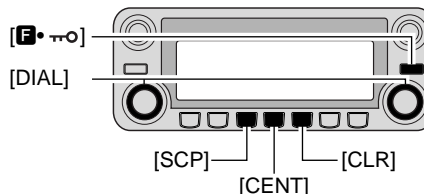
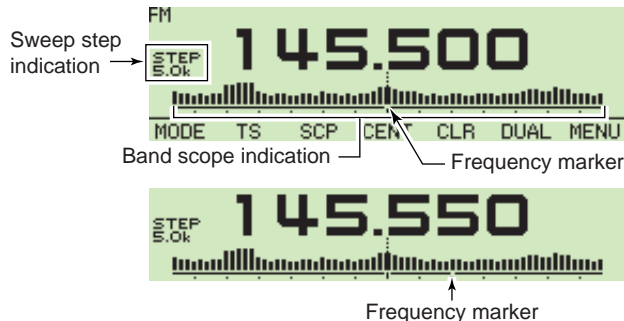

### ◇ Single sweep

- ① Set the desired frequency as band scope center frequency.
- ② Push **[F•---○]** to display the function guide.
- ③ Push **[SCP](DUP•MONI)** to start a single sweep.
  - 1 short beep sounds.
  - Signal strengths appear starting from the lower edge of the range.
- ④ Rotate **[DIAL]** to set the frequency marker to the desired signal and set the frequency of the signal.
- ⑤ Push **[F•---○]** to display the function guide, then push **[CLR](LOW•PRIO)** to clear the band scope.

### ◇ Continuous sweep

- ① Set the desired frequency as band scope center frequency.
- ② Push **[F•---○]** to display the function guide.
- ③ Push and hold **[SCP](DUP•MONI)** for 1 sec. to start continuous sweep.
  - 1 short and 1 long beeps sound.
  - Signal strengths appear starting from the center of the range.
- ④ To stop sweeping, push **[F•---○]** to display the function guide, then push **[SCP](DUP•MONI)**.
- ⑤ Push **[F•---○]** to display the function guide, then push **[CLR](LOW•PRIO)** to clear the band scope.

/// The receive audio during sweeping can be muted in sounds set mode. See page 109 for details.

### ◇ Monitoring a signal

If you find a signal that you want to monitor during/after sweep, you can monitor the signal with the following operation.

- ① Push **[F•---○]** to display the function guide, then push **[SCP](DUP•MONI)** to cancel the continuous sweep, if necessary.
- ② Rotate **[DIAL]** to tune into the desired signal.
- ③ Push **[CENT](TONE•DTMF)** to return to the center frequency.

## ■ General

Repeaters allow you to extend the operational range of your radio because a repeater has much higher output power than the typical transceiver.

Normally, a repeater has independent frequencies for each receiver and transmitter.

A subaudible tone may also be required to access a repeater.

Reference amateur radio handbooks and local ham magazines for details of local repeaters such as repeater input/output frequencies and locations.

### Repeater example;

Receives the 444.540 MHz signal and the detected audio signals are transmitted on 449.540 MHz simultaneously.

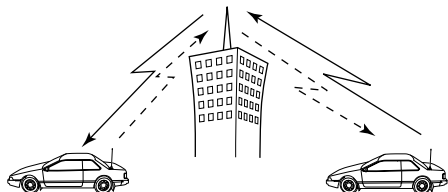

Station A:  
Tx: 444.540 MHz  
Rx: 449.540 MHz

Station B:  
Tx: 444.540 MHz  
Rx: 449.540 MHz

### • Repeater operation flow chart

#### Step 1:

Set the desired band to operate the repeater.

#### Step 2:

Set the desired receive frequency (repeater output frequency).

#### Step 3:

Set the duplex (shift) direction (- duplex or +duplex).  
- Set the offset frequency (amount of shift), if required.

#### Step 4:

Set the subaudible tone (repeater tone) encoder function ON.  
- Set the subaudible tone frequency, if required.

- The IC-2820H USA version has the auto repeater function. Thus the steps 3 and 4 may not be necessary, depending on the setting.
- Repeater settings can be stored into a memory channel.

## ■ Accessing a repeater

- ① Set the receive frequency (repeater output frequency) on the main band. (pgs. 15–17)
- ② Push **[DUP•MONI]** one or two times, to select minus duplex or plus duplex.
  - “DUP–” or “DUP+” appears to indicate the transmit frequency for minus shift or plus shift, respectively.
  - When the auto repeater function is turned ON (available for the USA version only), steps ② and ③ are not necessary. (p. 35)

“DUP–” or “DUP+” appears

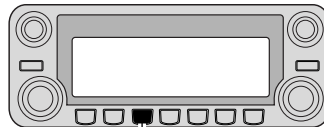
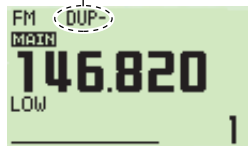

[DUP•MONI]

- ③ Push **[TONE•DTMF]** several times to turn ON the subaudible tone encoder, according to repeater requirements.
  - “TONE” appears
  - 88.5 Hz is set as the default; refer to p. 32 for tone frequency settings.
  - When the repeater requires a different tone system, see p. 33.

“TONE” appears

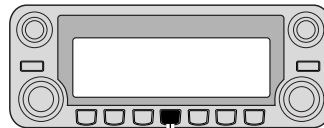

[TONE•DTMF]

- ④ Push and hold **[PTT]** to transmit.
  - The displayed frequency automatically changes to the transmit frequency (repeater input frequency).
  - If “OFF” appears, confirm that the offset frequency (p. 34) is set correctly.
- ⑤ Release **[PTT]** to receive.

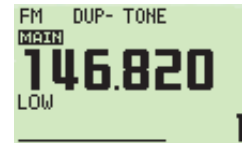

While receiving

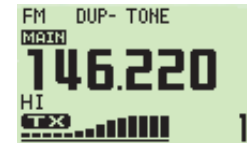

While transmitting

- ⑥ Push **[DUP•MONI]** to check whether the other station's transmit signal can be received directly.
- ⑦ To return to simplex operation, push **[DUP•MONI]** once or twice, to clear the “DUP–” or “DUP+” indicator.
- ⑧ To turn OFF the subaudible tone encoder, push **[TONE•DTMF]** several times until no tone indicators appear.

## 4 REPEATER OPERATION



- 1 Set the receive frequency (repeater output frequency) on the main band. (pgs. 16, 17)
- 2 Push [DUP- 7(TONE)] to select minus duplex; push [DUP+ 8(TSQL ((•))) ] to select plus duplex.
  - “DUP-” or “DUP+” appears.

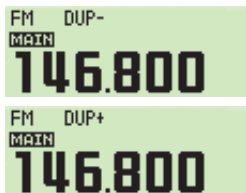
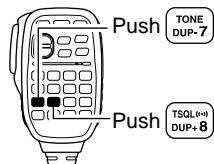

- 3 Push [FUNC] then [DUP- 7(TONE)] to turn ON the subaudible tone encoder according to repeater requirements.
  - Refer to p. 32 for the tone frequency setting.
  - When the repeater requires a different tone system, see p. 33.

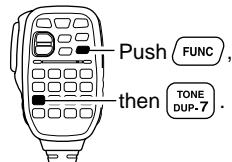

- 4 Push and hold [PTT] to transmit.
- 5 Release [PTT] to receive.
- 6 Push [MONI 1(BANK)] to check whether the other station's transmit signal can be received directly.



- 7 Push [SIMP 9(TSQL)] to return to simplex operation.
  - “DUP+” or “DUP-” indicator disappears.
- 8 To turn OFF the subaudible tone encoder, push [FUNC] then [ENT C(T-OFF)].

## ■ Subaudible tones (Encoder function)

### ◇ Subaudible tones

- ① Select the main band, mode/channel you wish to set the subaudible tones to, such as VFO mode or memory/call channel.
- ② Push **[F•T•O]** to display the function guide.
- ③ Push **[MENU](V/MHz•SCAN)** (Right band's) to enter MENU screen.
- ④ Rotate **[DIAL]** to select "DUP/TONE..." then push **[MAIN•BAND]**.
- ⑤ Rotate **[DIAL]** to select "REPEATER TONE" then push **[MAIN•BAND]**.
- ⑥ Rotate **[DIAL]** to select and set the desired subaudible frequency, then push **[MAIN•BAND]**.

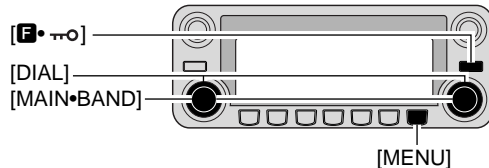

- ⑦ Push **[BACK](V/MHz•SCAN)** (Right band's) twice to exit DUP/TONE set mode.

**NOTE:** The subaudible tone encoder frequency can be set in a memory/call channel temporarily. However, the set frequency is cleared once another memory channel or VFO mode is selected. To store the tone frequency permanently, overwrite the channel information.



- ① Set the main band, mode/channel you wish to set the subaudible tones for, such as VFO mode or memory/call channel.
  - The subaudible tone frequency is independently programmed into each mode or channel.
- ② Push **[SET B(D-OFF)]** to enter MENU screen.
- ③ Push **[▲]** or **[▼]** to select "DUP/TONE..." then push **[SET B(D-OFF)]**.
- ④ Push **[▲]** or **[▼]** to select "REPEATER TONE" then push **[SET B(D-OFF)]**.
- ⑤ Push **[▲]** or **[▼]** to select the desired subaudible tone frequency then push **[SET B(D-OFF)]**.

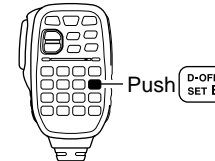

- ⑥ Push **[CLR A(MW)]** to return VFO mode.

### • Subaudible tone frequency list

(unit: Hz)

67.0	79.7	94.8	110.9	131.8	156.7	171.3	186.2	203.5	229.1
69.3	82.5	97.4	114.8	136.5	159.8	173.8	189.9	206.5	233.6
71.9	85.4	100.0	118.8	141.3	162.2	177.3	192.8	210.7	241.8
74.4	88.5	103.5	123.0	146.2	165.5	179.9	196.6	218.1	250.3
77.0	91.5	107.2	127.3	151.4	167.9	183.5	199.5	225.7	254.1

## 4 REPEATER OPERATION

### ◇ DTMF tones



➔ Push [DTMF-S], then push the keys of the desired DTMF digits.

- The function indicator lights green.
- 0–9, A–D, \*(E) and #(F) are available.
- When “☎” is displayed, cancel the DTMF memory encoder in advance. (p. 83)
- Push [DTMF-S] again to return the keypad to normal function control.

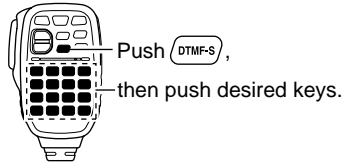

### ✓ For your convenience!

The transceiver has 16 DTMF memory channels for autopatch operation. See p. 82 for details.

### ◇ 1750 Hz tone

The microphone has 1750 Hz tone capability, used for ring tone when calling, etc.



1 Push [FUNC].

- The function indicator lights orange.

2 Push [\*(TONE-1)] to transmit a 1750 Hz tone call signal for 0.5 sec.; push and hold [0(TONE-2)] to transmit a 1750 Hz tone call signal for an arbitrary period.

- The function indicator goes out automatically.

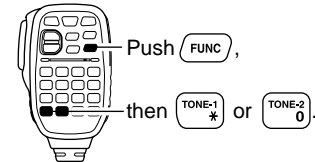

## ■ Offset frequency

When communicating through a repeater, the transmit frequency is shifted from the receive frequency by an amount determined by the offset frequency.

Independent offset frequencies can be set for each operating frequency band.

- ① Push **[MAIN•BAND]** to select the desired band (left or right) as the main band.
- ② Select the desired mode/channel you wish to set the offset frequency for, such as VFO mode or memory/call channel.
- ③ Push **[F••••]** to display the function guide then push **[MENU](V/MHz•SCAN)** (Right band's) to enter MENU screen.
- ④ Rotate **[DIAL]** to select "DUP/TONE...", then push **[MAIN•BAND]**.
- ⑤ Rotate **[DIAL]** to select "OFFSET FREQ" item, then push **[MAIN•BAND]**.
- ⑥ Rotate **[DIAL]** to set the desired offset frequency.
  - Push **[MHz](V/MHz•SCAN)** (Left band's) to turn 1 MHz tuning ON and OFF

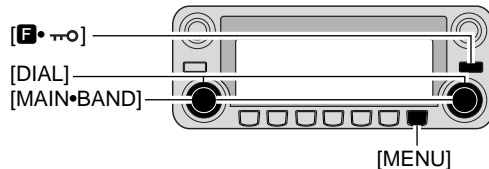

- ⑦ Push **[BACK](V/MHz•SCAN)** (Right band's) twice to exit DUP/TONE set mode.



- ① Push **[BAND]** to select the desired band (left or right) as the main band.
  - Enter the desired frequency via the keypad if necessary.
- ② Select the desired mode/channel you wish to set the offset frequency for, such as VFO mode or memory/call channel.
  - The offset frequency can be independently programmed into each mode or channel.
- ③ Push **[SET B(D-OFF)]** to enter MENU screen.
- ④ Push **[▲]** or **[▼]** to select "DUP/TONE..." then push **[SET B(D-OFF)]**.
- ⑤ Push **[▲]** or **[▼]** to select "OFFSET FREQ" then push **[SET B(D-OFF)]**.
- ⑥ Push **[▲]** or **[▼]** to set the desired offset.
  - Direct frequency entry from the keypad is not possible.
- ⑦ Push **[CLR A(MW)]** to exit set mode.

**NOTE:** The offset frequency can be set in a memory/call channel temporarily. However, the set frequency is cleared once another memory channel or VFO mode is selected. To store the offset frequency permanently, overwrite the channel information.

## 4 REPEATER OPERATION

### ■ Auto repeater

The USA and Korean versions automatically use standard repeater settings (duplex ON/OFF, duplex direction, tone encoder ON/OFF) when the operating frequency falls within or outside of the general repeater output frequency range. The offset and repeater tone frequencies are not changed by the auto repeater function. Reset these frequencies, if necessary.

#### ◇ Frequency range and offset direction

##### • USA version

FREQUENCY RANGE	SHIFT DIRECTION
145.200–145.495 MHz 146.610–146.995 MHz	“DUP–” appears
147.000–147.395 MHz	“DUP+” appears
442.000–444.995 MHz	“DUP+” appears
447.000–449.995 MHz	“DUP–” appears

##### • Korean version

FREQUENCY RANGE	SHIFT DIRECTION
439.000–440.000 MHz	“DUP–” appears

#### USA/KOREAN versions only

- ① Push **[F•T•O]** to display the function guide.
- ② Push **[MENU](V/MHz•SCAN)** (Right band's) to enter MENU screen.
- ③ Rotate **[DIAL]** to select “SET MODE” then push **[MAIN•BAND]**.
- ④ Rotate **[DIAL]** to select “AUTO REPEATER” then push **[MAIN•BAND]**.
- ⑤ Rotate **[DIAL]** to select the auto repeater setting.

##### [USA version]:

- “RPT1” : Activates duplex only. (default)
- “RPT2” : Activates duplex and tone.
- “OFF” : Auto repeater function is turned OFF.

##### [Korean version]:

- “ON” : Activates duplex and tone. (default)
- “OFF” : Auto repeater function is turned OFF.

- ⑥ Push **[BACK](V/MHz•SCAN)** (Right band's) twice to exit from set mode.

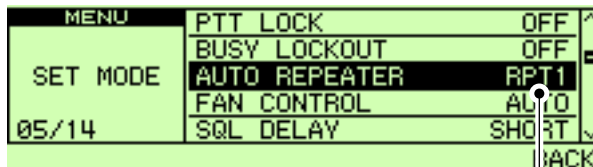

Auto Repeater set: ON1  
(USA version)

### ■ Digital mode operation

The IC-2820H can be operated in digital voice mode and low-speed data operation for both transmit and receive when the optional UT-123 is installed. Also, position data transmission and reception are available with the UT-123. A GPS antenna is supplied with the UT-123.

### ■ Call sign programming

Four types of call sign memories are available: your own call sign "MY CALL SIGN," other station call sign "YOUR CALL SIGN," repeater call sign "RPT1 CALL SIGN" and "RPT2 CALL SIGN." "MY CALL SIGN" can store up to 6 call signs, "YOUR CALL SIGN" can store up to 60 call signs and "RPT1/2 CALL SIGN" can store up to 60 call signs, and each call sign can be programmed with up to 8 characters.

## 5 DV MODE OPERATION (Optional UT-123 is required)

### ◆ Your own call sign programming

Your own call sign must be programmed for both digital voice and low-speed data communications (including GPS transmission).

- ① Push **[F••••]** to display the function guide.
- ② Push **[MENU](V/MHz•SCAN)** (Right band's) to enter MENU screen.
- ③ Rotate **[DIAL]** to select "CALL SIGN MEMORY" then push **[MAIN•BAND]**.
- ④ Rotate **[DIAL]** to select "MY CALL SIGN MEMORY" then push **[MAIN•BAND]**.
- ⑤ Rotate **[DIAL]** to select the desired call sign channel (M01 to M06), then push **[MAIN•BAND]**.



- ⑥ Rotate **[DIAL]** to select the desired character, then push **[>](M/CALL•MW)** (Left band's) to move the cursor right.
  - Push **[<](V/MHz•SCAN)** (Left band's) to move the cursor left.
  - Up to 8-character call signs can be entered.
  - Push **[ABC](TONE•DTMF)** to select the character group from capital letter characters.
  - Push **[12/](M/CALL•MW)** (Right band's) to select the character group from numbers or symbols.
  - Push **[CLR](DUP•MONI)** to clear the selected character.

- ⑦ Repeat step ⑥ until your own call sign is programmed.



- ⑧ Push **[>](M/CALL•MW)** (Left band's) several times to move the cursor to " / " position.
  - A to Z, 0 to 9 and " / " characters are available.
  - If no note is required, skip steps ⑧ and ⑨, go to step ⑩.
- ⑨ Repeat step ⑥ to program the desired 4-character note.
- ⑩ Push **[MAIN•BAND]** to store the programmed call sign (or with note).

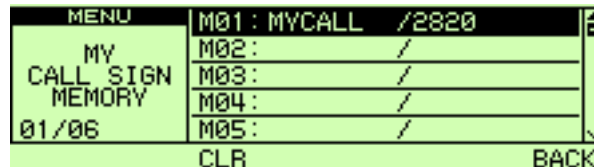

- ⑪ Push **[BACK](V/MHz•SCAN)** (Right band's) three times to return to frequency indication.

### ◆ Station call sign programming

Station call signs must be programmed for the specified station call as well as repeater operation in all digital voice, low-speed data and GPS communications.

- ① Push [**F**•**---**•**0**] to display the function guide.
- ② Push [**MENU**](**V/MHz•SCAN**) (Right band's) to enter MENU screen.
- ③ Rotate [**DIAL**] to select "CALL SIGN MEMORY" then push [**MAIN•BAND**].
- ④ Rotate [**DIAL**] to select "YOUR CALL SIGN MEMORY" then push [**MAIN•BAND**].
- ⑤ Rotate [**DIAL**] to select the desired call sign channel (U01 to U60), then push [**MAIN•BAND**].

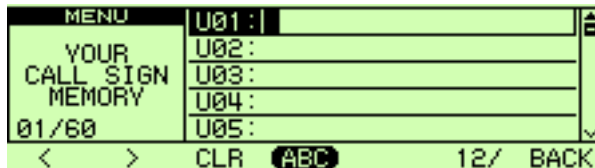

- ⑥ Rotate [**DIAL**] to select the desired character, then push [**>**](**M/CALL•MW**) (Left band's) to move the cursor right.
  - Push [**<**](**V/MHz•SCAN**) (Left band's) to move the cursor left.
  - Up to 8-character call signs can be entered.
  - Push [**ABC**](**TONE•DTMF**) to select the character group from capital letter characters.
  - Push [**12/**](**M/CALL•MW**) (Right band's) to select the character group from numbers or symbol.
  - Push [**CLR**](**DUP•MONI**) to clear the selected character.

- ⑦ Repeat step ⑥ until the desired station call sign is programmed.



- ⑧ Push [**MAIN•BAND**] to store the programmed call sign.



- ⑨ Push [**BACK**](**V/MHz•SCAN**) (Right band's) three times to return to frequency indication.

## 5 DV MODE OPERATION (Optional UT-123 is required)

### ■ Digital voice mode operation

- ① Set the desired band (Left or Right) as the main band. (p. 15)
  - Select output power, if desired. (p. 21)
- ② Select DV mode. (p. 21)
- ③ Set your own call sign for DV operation as follows.
  - ① Push [**F**•**—**•**0**] twice to display the function guide 2.
  - ② Push [**CS**](**V/MHz**•**SCAN**) (Left band's) to display call sign screen.

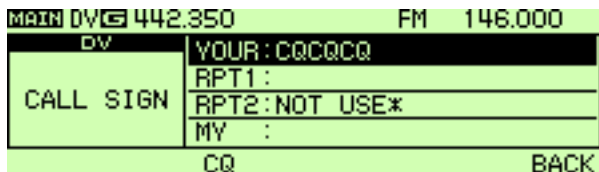

- ③ Rotate [**DIAL**] to select “MY” then push [**MAIN**•**BAND**].
- ④ Rotate [**DIAL**] to select the desired your own call sign memory channel, then push [**BACK**](**V/MHz**•**SCAN**) (Right band's) to set “MY CALL SIGN.”
  - See page 37 for your own call sign programming details.
- ④ Set the desired call sign as described in “When calling the desired station (p. 40)” or “When sending a CQ (p. 40).”
- ⑤ Push and hold [**PTT**] to transmit and speak into the microphone at normal voice level.
  - “**TX**” appears and the RF meter shows the output power.
- ⑥ Release [**PTT**] to return to receive.
  - The other station call sign will be received.
  - Received call signs can be stored into the received call record automatically. See page 47 for details.

/// **NOTE:** The digital mode operation is vastly different from FM mode. One of the differences is that in digital mode the squelch does not function as in FM mode. Changing the squelch setting will not open it to hear the hiss of “White Noise.” It only activates for digital squelch functions such as CSQL (Digital code squelch) or DSQL (Digital call sign squelch).

### ◆ When calling the desired station

Continued instruction from step 4 on page 39.

- 5 Rotate **[DIAL]** to select “YOUR,” then push **[MAIN•BAND]**.
  - YOUR CALL SIGN screen is displayed.
- 6 Rotate **[DIAL]** to select the call sign channel in which desired station’s call sign is programmed.
  - See page 38 for station call sign programming details.

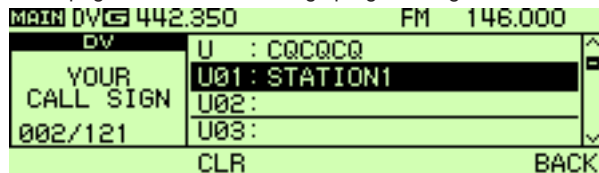

- 7 Push **[BACK](V/MHz•SCAN)** (Right band's) to set the station's call sign and return to CALL SIGN screen.
- 8 Push **[BACK](V/MHz•SCAN)** (Right band's) again to return to function guide 2 indication.
- 9 Perform the instruction steps 5 to 6 on page 39.

### ◆ When sending a CQ

Continued instruction from step 4 on page 39.

- 5 Push **[CQ](DUP•MONI)** to set “CQCQCQ” as the call sign.
- 6 Push **[BACK](V/MHz•SCAN)** (Right band's) to return to function guide 2 indication.
- 7 Perform the instruction step 5 to 6 on page 39.

### ✓ For your information!

Your own (MY) call sign, Station call sign and repeater call sign can also be programmed/edited in “CALL SIGN” screen.

In addition, when editing a call sign stored in a call sign memory, regular memory or call channel, the default operation is to over-write a programmed call sign in regular memory and call channels. (Temporary operation without over-writing is possible.) However, the edited call sign can store into a blank channel automatically when “AUTO” is set with the EDIT RECORD (p. 104).

- 1 While displaying “CALL SIGN” screen, rotate **[DIAL]** to select either “YOUR,” “RPT1/2” or “MY” then push **[MAIN•BAND]**.
- 2 Rotate **[DIAL]** to select the desired call sign memory channel then push **[MAIN•BAND]**.
- 3 Rotate **[DIAL]** to select the desired call sign memory channel then push **[MAIN•BAND]**.
- 4 Rotate **[DIAL]** to select the desired character.
  - Push **[ABC](TONE•DTMF)** to select the character group from capital letter characters.
  - Push **[12/](M/CALL•MW)** (Right band's) to select the character group from numbers or symbol.
  - Push **[>](M/CALL•MW)** (Left band's) or **[<](V/MHz•SCAN)** (Left band's) to move the cursor right or left, respectively.
  - Push **[CLR](DUP•MONI)** to clear the selected character.
  - Push **[GW](LOW•PRIO)** (available only when RPT1/2 is selected in step 1) to turn the gateway setting ON/OFF.
- 5 After the desired call sign (up to 8-characters) is entered, push **[BACK](V/MHz•SCAN)** (Right band's).

## 5 DV MODE OPERATION (Optional UT-123 is required)

### ■ About D-STAR system

In the D-STAR system, repeater linking via a 10 GHz band backbone and internet network (gateway connection) capabilities are available. This system provides you with much wider coverage range during digital voice mode operation.

#### • D-STAR system outline

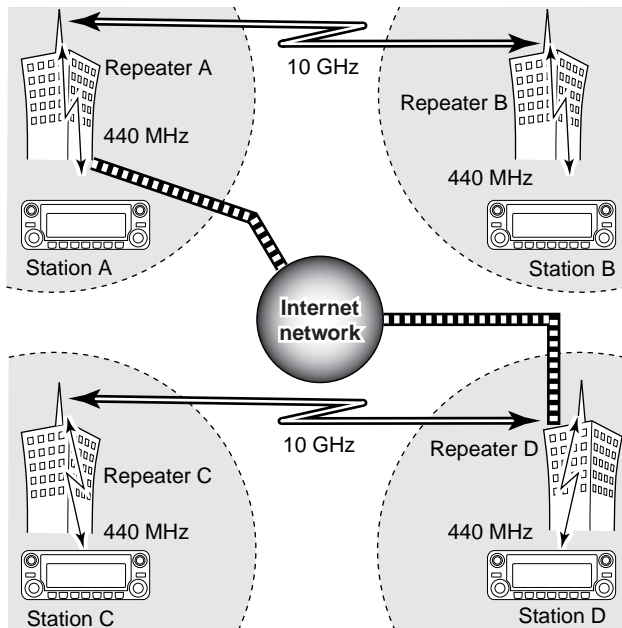

For current repeater operation, stations that are communicating must both be in the same repeater's operating area. However, in the D-STAR system as in the illustration at left, the repeaters can be linked via the system repeaters (with a 10 GHz signal). Thus stations A and B can communicate even though they are in different repeater operating areas.

Also, the D-STAR system repeaters are connectable through the INTERNET— gateway connection capability.

For example, when station B uses the gateway connection station B can communicate with the station C! By using the gateway connection, long distance DX communication may be possible with 144 or 440 MHz digital voice!

In the D-STAR system, an independent repeater's operating area is called an Area and a group that of linked repeaters via a 10 GHz backbone is called a Zone.

## ■ Digital repeater operation

Repeater call signs must be programmed for repeater operation in both digital voice and low-speed data communications.

### ◆ Repeater call sign programming

- ① Push **[F••••]** to display the function guide.
- ② Push **[MENU](V/MHz•SCAN)** (Right band's) to enter MENU screen.
- ③ Rotate **[DIAL]** to select "CALL SIGN MEMORY" then push **[MAIN•BAND]**.
- ④ Rotate **[DIAL]** to select "RPT CALL SIGN MEMORY" then push **[MAIN•BAND]**.

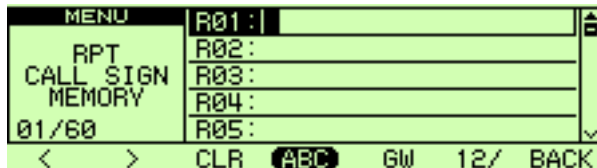

- ⑤ Rotate **[DIAL]** to select the desired call sign channel (R01 to R60), then push **[MAIN•BAND]**.

- ⑥ Rotate **[DIAL]** to select the desired character, then push **[>](M/CALL•MW)** (Left band's) to move the cursor right.
  - Push **[<](V/MHz•SCAN)** (Left band's) to move the cursor left.
  - Push **[ABC](TONE•DTMF)** to turn the character group from alphabetical characters capital letters.
  - Push **[12](M/CALL•MW)** (Right band's) to turn the character group from numbers or symbol.
  - Push **[CLR](DUP•MONI)** to clear the selected character.
  - Push **[GW](LOW•PRIO)** to turn the gateway setting ON/OFF.
- ⑦ Repeat step ⑥ until repeater call sign is programmed.

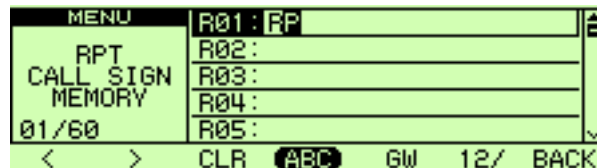

- ⑧ Push **[MAIN•BAND]** to store the programmed call sign.



- ⑨ Push **[BACK](V/MHz•SCAN)** (Right band's) three times to return to frequency indication.

## 5 DV MODE OPERATION (Optional UT-123 is required)

### ◆ Repeater operation in the same zone

- ① Set the desired repeater's frequency, offset and shift direction in the main band. (pgs. 30, 31)
  - Select DV mode in advance. (p. 21)
- ② Set your own call sign. (p. 39)
  - See p. 37 for your own call sign programming.
- ③ Set the desired station call sign. (p. 40)
  - See p. 38 for station call sign programming.
- ④ Set the repeater's call sign as follows;
  - ① Push **[F••••]** twice to display the function guide 2.
  - ② Push **[CS](V/MHz)** (Left band's) to display the "CALL SIGN" screen.
  - ③ Rotate **[DIAL]** to select "RPT1," then push **[MAIN•BAND]**.
    - RPT1 CALL SIGN screen is displayed.
  - ④ Rotate **[DIAL]** to select the nearest repeater's call sign then push **[BACK](V/MHz)** (Right band's).

MAIN DV 442.350 FM 146.000	
DV	YOUR: CQCQCQ
CALL SIGN	RPT1: RPT1AA
	RPT2: NOT USE*
	MY :MYCALL /2820
CQ	BACK

- ⑤ Rotate **[DIAL]** to select "RPT2" then push **[MAIN•BAND]**.
  - RPT2 CALL SIGN screen is displayed.
- ⑥ Rotate **[DIAL]** to select the desired repeater's (in the same zone) call sign.
  - Select "NOT USE\*" when not operating RPT2.

- ⑦ Push **[BACK](V/MHz•SCAN)** (Right band's) to exit "CALL SIGN" screen.
- ⑧ Push **[PTT]** to transmit; release to receive.

• **Setting example 1**

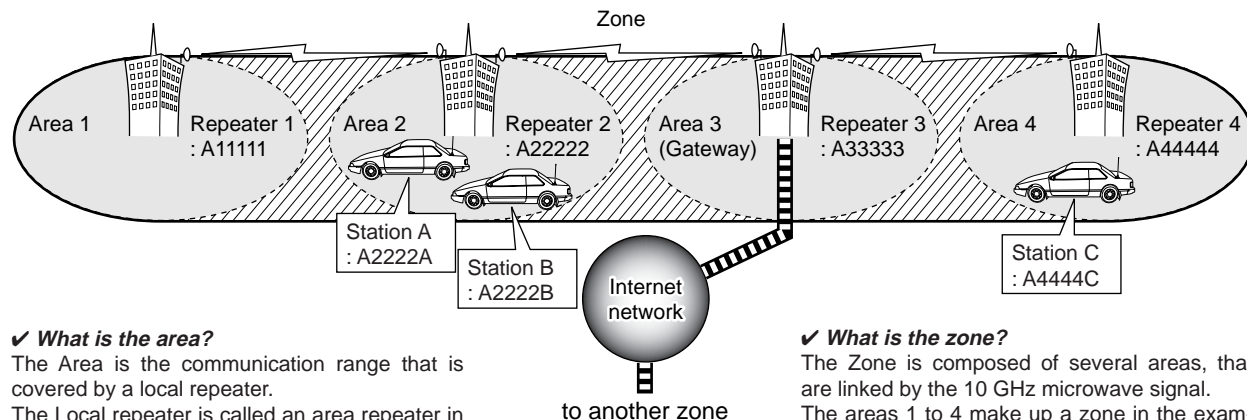

✓ **What is the area?**

The Area is the communication range that is covered by a local repeater.  
The Local repeater is called an area repeater in the D-STAR system.

✓ **What is the zone?**

The Zone is composed of several areas, that are linked by the 10 GHz microwave signal.  
The areas 1 to 4 make up a zone in the example above.

**The setting when Station A is calling Station B**

UR : A2222B  
R1 : A22222  
R2 : NOT USED  
MY : A2222A

**The setting when Station A is making a CQ call in area 1**

UR : CQCQCQ  
R1 : A22222  
R2 : A11111  
MY : A2222A

**The setting when Station A is calling Station C**

UR : A4444C  
R1 : A22222  
R2 : A44444  
MY : A2222A

## 5 DV MODE OPERATION (Optional UT-123 is required)

### ◆ Repeater operation into another zone

- ① Set the desired repeater's frequency, offset and shift direction in the main band. (pgs. 30, 31)
  - Select DV mode in advance. (p. 21)
- ② Set your own call sign. (p. 39)
  - See p. 37 for your own call sign programming.
- ③ Set the desired station call sign. (p. 40)
  - **When making a CQ call**  
Set the desired repeater's (in a different zone) call sign into "YOUR." The symbol "I" which stands for "CQCQCQ" is added at the 1st digit automatically.
    - See p. 38 for station call sign programming.
- ④ Set the repeater's call sign as follows;
  - ① Push [**F**•**—**•**o**] twice to display the function guide 2.
  - ② Push [**CS**](V/MHz•SCAN) (Left band's) to display the "CALL SIGN" screen.
  - ③ Rotate [**DIAL**] to select "RPT1," then push [**MAIN**•**BAND**].
    - RPT1 CALL SIGN screen is displayed.
  - ④ Rotate [**DIAL**] to select the nearest repeater's call sign then push [**BACK**](V/MHz) (Right band's).
    - If the nearest repeater is a gateway repeater, program the repeater's call sign with "G" in the 8th digit.

MAIN DV G 442.350 FM 146.000	
DV	YOUR: CQCQCQ
CALL SIGN	RPT1: RPT1AA
	RPT2: NOT USE*
	MY : MYCALL /2820
CQ	BACK

- ⑤ Rotate [**DIAL**] to select "RPT2" then push [**MAIN**•**BAND**].
    - RPT2 CALL SIGN screen is displayed.
  - ⑥ Rotate [**DIAL**] to select the gateway repeater's (in the same zone) call sign.
    - The call sign should have "G" in the 8th digit.
    - When gateway repeater call sign is set in "RPT1," select "NOT USE\*" for "RPT2" setting.
  - ⑦ Push [**BACK**](V/MHz•SCAN) (Right band's) to exit "CALL SIGN" screen.
- ⑤ Push [**PTT**] to transmit; release to receive.

• Setting example 2

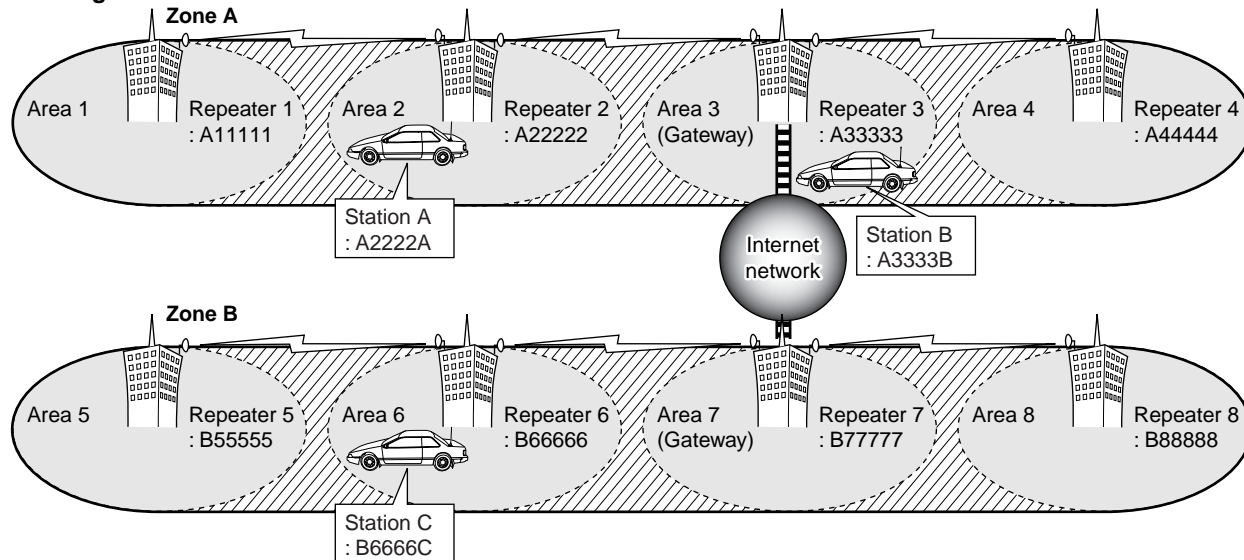

5

The setting when Station A is calling Station C

UR : B6666C  
 R1 : A22222  
 R2 : A33333 G  
 MY : A2222A

The setting when Station A is making a CQ call in area 8

UR : /B88888  
 R1 : A22222  
 R2 : A33333 G  
 MY : A2222A

The setting when Station B is calling Station C

UR : B6666C  
 R1 : A33333 G  
 R2 : NOT USE\*  
 MY : A33333B

## 5 DV MODE OPERATION (Optional UT-123 is required)

### ■ Received call sign

When a call is received in DV mode, the calling station and the repeater call signs being used can be stored into the received call record. The stored call signs are viewable in the following manner.

Up to 20 calls can be recorded.

#### ◇ Desired call record indication

① Display the RX call sign record screen;

**Accessing from MENU screen:**

① Push [**F**•**---**•**0**] to display the function guide.

② Push [**MENU**](V/MHz•SCAN) (Right band's) to display the "MENU" screen.

③ Rotate [**DIAL**] to select "RX CALL SIGN," then push [**MAIN**•**BAND**].

**Accessing from function guide 2:**

① Push [**F**•**---**•**0**] twice to display the function guide 2.

② Push [**CD**](M/CALL•MW) (Left band's) to display the "RX CALL SIGN" screen.

② Rotate [**DIAL**] to select the desired record.

③ Push [**MAIN**•**BAND**] to display the received call details.

- **CALLER** : The station call sign that made a call.
- **CALLED** : The station call sign called by the caller.
- **RXRPT1** : The repeater call sign used by the caller station.
- **RXRPT2** : The repeater call sign linked from RXRPT1.

MAIN DV 442.350 FM 146.000	
DV	CALLER: AAAAAA /
RX CALL SIGN	CALLED: CQCQCQ
RX01	RXRPT1:
	RXRPT2:
	R>CS BACK

\*The above screen is displayed when accessing the RX CALL SIGN screen from function guide 2. A different screen is displayed when accessing the screen from MENU screen.

④ Push [**MAIN**•**BAND**] or [**BACK**](V/MHz•SCAN) (Right band's) to return to the "RX CALL SIGN" screen.

⑤ Push [**BACK**](V/MHz•SCAN) (Right band's) to exit from the "RX CALL SIGN" screen.

#### ✓ For your information

When receiving a call, the received station call sign is automatically displayed at the bottom line of the function display. This can be turned ON in display set mode. (p.108)

**◇ One-touch reply**

- ① After receiving a call, push [**F**•**↔**] twice to display the function guide 2.
- ② Push [**R>CS**](**TONE**•**DTMF**) to set the received call sign as for the call.

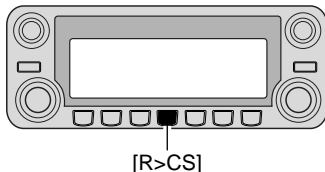
**◇ One-touch reply using the call record**

The stored call signs in the call record can be used to the call.

- ① Perform the steps ① and ② of “◇ Desired call record indication” described on the previous page.

**➔ When selecting a call record via MENU screen:**

- ② Push [**MAIN**•**BAND**] to display the call record details.
- ③ Push [**R>CS**](**V/MHz**•**SCAN**) (Left band's) to set the received call sign to that of the call record.

**➔ Setting from function guide 2:**

- ② Push [**R>CS**](**TONE**•**DTMF**) to set the received call sign to that of the call record.

After the above operations, push [**PTT**] to transmit; release to receive.

**NOTE:**

- Set your own call sign (MY) in advance. (p. 39)
- The call sign stored in “CALLER” is stored as “YOUR,” “RXRPT1” is stored as “RPT2” and “RXRPT2” is stored as “RPT1.”
- Error beeps sound when a call sign is received incorrectly, and no call sign is set in this case.

**Important!**

Setting call signs with the “One-touch reply using the call record” operation as at left are for temporary operation only. Therefore, the set call signs will be overwritten when another call record is used to set call signs.

- Never save into a call sign memory.

If you want to save the set call signs, see “Copying the call record contents into call sign memory” (p. 50) for details.

**✓ For your information**

When a call specifying your call sign is received, the call signs of the calling station and the repeater it is using can be used for operation automatically.

- When “RX call sign auto write” (p. 103) is set to “AUTO,” the station call sign in “CALLER” is set to “YOUR” automatically.
- When “Repeater call sign auto write” (p. 104) is set to “AUTO,” the stored station call sign in “RXRPT1” is stored as “RPT2” and “RXRPT2” is stored as “RPT1” automatically.

## 5 DV MODE OPERATION (Optional UT-123 is required)

### ■ Copying the call sign

#### ◆ Copying the call sign memory contents

This function is convenient when modifying part of the current call sign.

**NOTE:** Make sure that the “EDIT RECORD” item in DV set mode is set to “AUTO” in advance. (p. 104)

- ① Push **[F•T•O]** twice to display the function guide 2.
- ② Push **[CS](V/MHz•SCAN)** (Left band's) to display the “CALL SIGN” screen.
- ③ Rotate **[DIAL]** to select “YOUR” or “RPT1/2” then push **[MAIN•BAND]**.
- ④ Rotate **[DIAL]** to select the desired call sign channel.
  - U01–U60 and R01–R60 are available.
- ⑤ Push **[MAIN•BAND]**.
  - The selected call sign channel contents are copied into a blank channel automatically and call sign programming mode is selected.
- ⑥ Edit or modify the copied call sign as follows;
  - Push **[<](V/MHz•SCAN)** (Left band's) **[>](M/CALL•MW)** (Left band's) or to move the cursor left or right, respectively.
  - Push **[ABC](TONE•DTMF)** to turn the character group from alphabetical characters capital letters.
  - Push **[12/](M/CALL•MW)** (Right band's) to turn the character group from numbers or symbol.
  - Push **[CLR](DUP•MONI)** to clear the selected character.
  - Push **[GW](LOW•PRIO)** to turn the gateway setting ON/OFF. (available only when “RPT1/2” is selected in step ③)

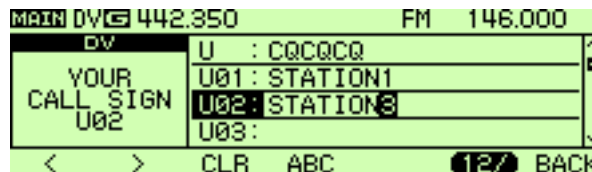

- ⑦ Push **[BACK](V/MHz•SCAN)** (Right band's) to store the edited/modified call sign into the selected blank channel, or push **[MAIN•BAND]** to store the call sign into the channel and set for the call.

**NOTE:**

The message “FULL” is displayed when no blank channel is available in the station or repeater call sign memory.

### ◆ Copying the call record contents into call sign memory

This is a way to copy the call record contents (“CALLER,” “RXRPT1” and “RXRPT2”) into call sign memory (“YOUR” and “RPT”) at the same time or individually.

- ① Push [**F**•**---**] to display the function guide.
- ② Push [**MENU**](V/MHz•**SCAN**) (Right band's) to display the “MENU” screen.
- ③ Rotate [**DIAL**] to select “RX CALL SIGN,” then push [**MAIN**•**BAND**].
- ④ Rotate [**DIAL**] to select the desired record channel, then push [**MAIN**•**BAND**].
  - COPY SELECT screen is displayed.

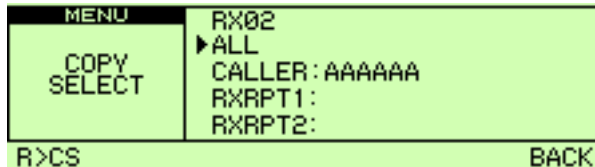

- ⑤ Rotate [**DIAL**] to select the desired call sign to be copied from “ALL,” “CALLER,” “RXRPT1” and “RXRPT2.”
  - “ALL” selection won’t appear when either station or repeater call sign memory has no blank channel.

#### • When “ALL” is selected

- ➔ Push [**MAIN**•**BAND**] to copy the selected record’s contents into the appropriate call sign memory’s blank channel automatically.
  - Returns to RX CALL SIGN screen automatically.

#### • When “CALLER,” “RXRPT1” or “RXRPT2” is selected

- ① Push [**MAIN**•**BAND**] then rotate [**DIAL**] to select the desired condition of call sign memory channel selection to be copied to from “AUTO” and “LIST SEL.”
  - “AUTO” selection won’t appear when the appropriate call sign memory has no blank channel.
  - Go to step ⑥ when “AUTO” is selected.

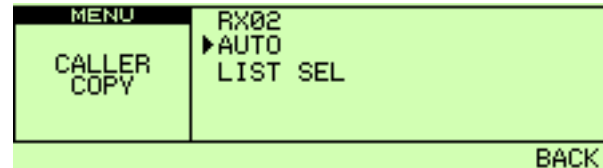

- ② Push [**MAIN**•**BAND**] then select the desired call sign memory channel to copy to with [**DIAL**].
  - Programmed call sign is displayed if the selected memory channel has already been programmed.

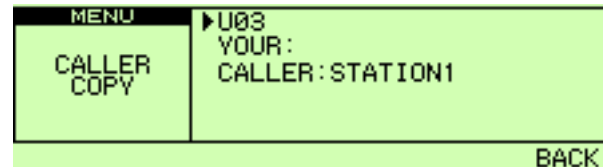

- ③ Push [**MAIN**•**BAND**] to copy the call sign into the selected call sign memory.
  - Returns to RX CALL SIGN screen automatically.

- ⑥ Push [**BACK**](V/MHz•**SCAN**) (Right band's) three times to return to frequency indication.

## 5 DV MODE OPERATION (Optional UT-123 is required)

### ■ Break-in communication

The break-in function allows you to break into a conversation, where the two original stations are communicating with call sign squelch enabled.

- ① While receiving an another station's communication, push **[F•T•O]** twice to display the function guide 2 and then push **[R>CS](TONE•DUP)** to set the communicating station's call sign.
  - When a call sign has not been received correctly, error beeps sound and no call sign is set. Receive the call sign of a communicating signal again, or set the call sign manually.
- ② Push **[MENU](V/MHz•SCAN)** (Right band's) to display the "MENU" screen.
- ③ Rotate **[DIAL]** to select "DV SET MODE," then push **[MAIN•BAND]** to enter DV set mode.
- ④ Rotate **[DIAL]** to select "BK," then push **[MAIN•BAND]** and rotate **[DIAL]** to turn the break-in function ON.
- ⑤ Push **[MAIN•BAND]** to set the selection, then push **[BACK](V/MHz•SCAN)** twice to return to frequency indication.
  - "BK" appears.



- ⑥ When both stations are in standby, push **[PTT]** to transmit a break-in call.
  - The programmed call sign station receives the break-in call as well as your call sign.
- ⑦ Wait for the reply call from the station who receives the break-in call.
- ⑧ After receiving the reply call, communicate normally.
- ⑨ To cancel the break-in, select "OFF" in BK in DV set mode.

#### • How to use the break-in?

##### • Station C calling Station A with "BK OFF"

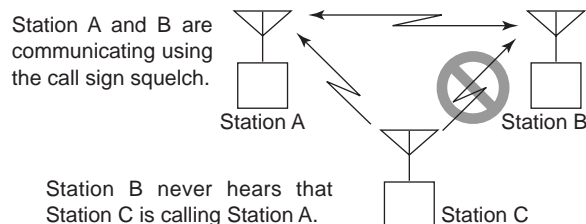

##### • Station C calling Station A with "BK ON"

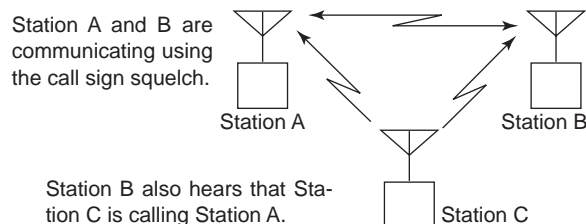

## ■ Message operation

### ◇ TX message programming

TX messages are available for up to 5 channels, and each channel can be programmed with a message of up to 20 characters. Available characters are **0** to **9**, **A** to **Z** (capital letters), **a** to **z** (lower case letters), some symbols and space.

- ① Push **[F••••]** to display the function guide.
- ② Push **[MENU](V/MHz•SCAN)** (Right band's) to display the "MENU" screen.
- ③ Rotate **[DIAL]** to select "DV MESSAGE," then push **[MAIN•BAND]**.
- ④ Rotate **[DIAL]** to select "TX MESSAGE MEMORY," then push **[MAIN•BAND]**.
- ⑤ Rotate **[DIAL]** to select the desired message memory channel, 01 to 05, then push **[MAIN•BAND]**.
  - Previously message is displayed if programmed.
- ⑥ Rotate **[DIAL]** to select the desired character.
  - Push **[Aa](TONE•DTMF)** to turn the character group from alphabetical characters capital letters or lower case letters.
  - Push **[1/](M/CALL•MW)** (Right band's) to turn the character group from numbers or symbols.
  - Push **[>](M/CALL•MW)** or **[<](V/MHz•SCAN)** (Left band's) to move the cursor right or left, respectively.
  - Push **[CLR](DUP•MONI)** to clear the selected character.

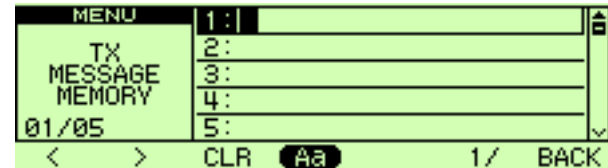

- ⑦ Repeat the step ⑥ to enter the desired message.
  - Up to 20-character messages can be set.

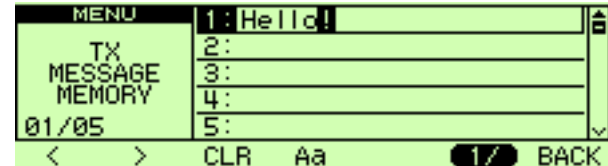

- ⑧ Push **[MAIN•BAND]** to store the message.
- ③ Push **[BACK](V/MHz•SCAN)** (Right band's) twice to exit from DV message screen.

## 5 DV MODE OPERATION (Optional UT-123 is required)

### ◇ Message Transmission

Select the message transmission function ON (Ch01–05) and OFF. When a message channel is selected, the transceiver transmits a text message (pre-programmed). (default: OFF)

- ① Push [**F**•**—**•**o**] twice to display the function guide 2.
- ② Push [**MSG**](**LOW**•**PRIO**) to display the “MESSAGE” screen.
- ③ Rotate [**DIAL**] to select “TX MESSAGE,” then push [**MAIN**•**BAND**].
- ④ Rotate [**DIAL**] to select the desired message channel.
  - “Ch01” to “Ch05” available.
  - See page 52 for message programming.
- ⑤ Push [**BACK**](**V/MHz**•**SCAN**) (Right band's) to set the message for transmission.
- ⑥ Push [**BACK**](**V/MHz**•**SCAN**) (Right band's) again to return to function guide 2 indication.
- ⑦ Push [**PTT**] to transmit the selected message.
  - The message is transmitted each time [PTT] is pushed.
  - The message is transmitted each 30 sec. automatically during continuous transmission.
- ⑧ Release [**PTT**] to return to receive.
- ⑨ When the reply call with a message is received, the call sign and the message displays alternately at the bottom of the function display.

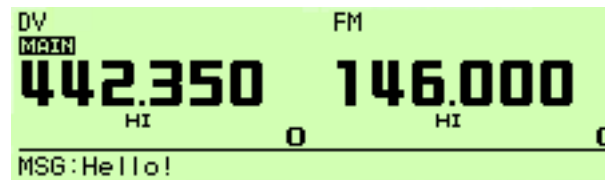

#### ✓ For your information

The automatic received call sign and/or message indication can be turned OFF in display set mode, if desired.

➔ RX CALL SIGN (p. 108)

➔ RX MESSAGE (p. 108)

⚠ **NOTE:** Only 1 message can be stored in the IC-2820H. The received message is cleared by turning power OFF, or overwritten when another message is received. A transmitted message that includes lower case characters from the IC-2820H may not be decoded and displayed correctly by the ID-800H, IC-V82/U82, etc.

## ◇ RX message indication

The received message can also be checked via MENU screen and function guide 2.

### ➔ Via MENU screen

- ① Push [**F**•**→**] to display the function guide.
- ② Push [**MENU**](V/MHz•SCAN) (Right band's) to display the "MENU" screen.
- ③ Rotate [**DIAL**] to select "DV MESSAGE," then push [**MAIN•BAND**].
- ④ Rotate [**DIAL**] to select "RX MESSAGE," then push [**MAIN•BAND**].
  - The received message with the call sign is displayed in RX MESSAGE screen.



- ⑤ Push [**BACK**](V/MHz•SCAN) (Right band's) three times to return to frequency indication.

### ➔ Via function guide 2

- ① Push [**F**•**→**] twice to display the function guide 2.
- ② Push [**MSG**](LOW•PRIO) to display the "MESSAGE" screen.
- ③ Rotate [**DIAL**] to select "RX MESSAGE," then push [**MAIN•BAND**].
  - The received message with the call sign is displayed in RX MESSAGE screen.

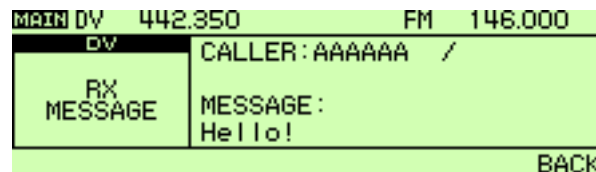

- ④ Push [**BACK**](V/MHz•SCAN) (Right band's) twice to return to function guide indication.

## 5 DV MODE OPERATION (Optional UT-123 is required)

### ■ Automatic reply function

The automatic reply function replies to calls by a station that specified your call sign.

Two methods of replying are available: one is making a reply call with your own call sign, and other one is making a reply call with reply voice audio that has been recorded in DV voice memory.

#### ◆ Automatic reply function setting

- ① Push [**F**•**MEMO**] to display the function guide.
- ② Push [**MENU**](V/MHz•SCAN) (Right band's) to display the "MENU" screen.
- ③ Rotate [**DIAL**] to select "DV SET MODE," then push [**MAIN**•**BAND**].
- ④ Rotate [**DIAL**] to select "AUTO REPLY," then push [**MAIN**•**BAND**].
- ⑤ Rotate [**DIAL**] to select the desired reply condition.  
**OFF** : Deactivate the automatic reply function. (default)  
**ON** : Reply to the call with your own call sign.  
**VOICE** : Reply to the call with the recorded voice memory.

MENU	AUTO REPLY	OFF	⬆
DV SET MODE	DIGITAL CODE	00	
	DV DATA TX	PTT	
	DIGITAL MONITOR	AUTO	
01/11	DIGITAL RPT SET	OFF	⬇
			BACK

- ⑥ Push [**BACK**](V/MHz•SCAN) (Right band's) three times to return to frequency indication.

#### ◆ Voice memory recording for automatic reply

##### **IMPORTANT!**

Set the transceiver for single band operation and/or set minimum [VOL] level for sub band when recording the reply voice. Otherwise received audio or unwanted noise from sub band is also recorded into the voice memory.

- ① Push [**F**•**MEMO**] to display the function guide.
- ② Push [**MENU**](V/MHz•SCAN) (Right band's) to display the "MENU" screen.
- ③ Rotate [**DIAL**] to select "DV VOICE MEMO," then push [**MAIN**•**BAND**].
- ④ Rotate [**DIAL**] to select "REPLY VOICE," then push [**MAIN**•**BAND**].



- Bar meter is displayed when the reply voice has already been recorded.
- ⑤ While pushing and holding [**PTT**], speak into the microphone.
    - Up to 10 seconds of message is recordable.
    - The recording stops after 10 second or when [**PTT**] is released.
  - ⑥ Push [**BACK**](V/MHz•SCAN) (Right band's) three times to exit from DV VOICE MEMO screen.

### ◆ Play-back or erase the voice memory

- ① Push [**F**•**---**•**0**] to display the function guide.
- ② Push [**MENU**](V/MHz•SCAN) (Right band's) to display the "MENU" screen.
- ③ Rotate [**DIAL**] to select "DV VOICE MEMO," then push [**MAIN**•**BAND**].
- ④ Rotate [**DIAL**] to select "REPLY VOICE," then push [**MAIN**•**BAND**].
- ⑤ To play-back the recorded reply voice, push [**▶**](LOW•PRIO).
  - Push [||||](LOW•PRIO) to pause, push [■](TONE•DUP) to cancel the play-back.



- ⑥ To erase the reply voice, push [**CLR**](DUP•MONI).
- ⑦ Push [**BACK**](V/MHz•SCAN) (Right band's) three times to exit from DV VOICE MEMO screen.

### ■ EMR communication

The EMR communication mode is available for digital mode operation. In the EMR communication mode, no call sign setting is necessary. When an EMR communication mode signal is received, the audio (voice) will be heard at the specified level even the volume setting level is set to minimum level, or digital call sign/digital code squelch is in use.

- ① Set the desired frequency in 144 or 440 MHz band.
- ② Push [**F**•**---**•**0**] to display the function guide.
- ③ Push [**MENU**](V/MHz•SCAN) (Right band's) to display the "MENU" screen.
- ④ Rotate [**DIAL**] to select "DV SET MODE," then push [**MAIN**•**BAND**].
- ⑤ Rotate [**DIAL**] to select "EMR," then push [**MAIN**•**BAND**].
- ⑥ Rotate [**DIAL**] to select "ON," then push [**MAIN**•**BAND**].
- ⑦ Push [**BACK**](V/MHz•SCAN) (Right band's) twice to exit from DV set mode.
  - "EMR" appears



- ⑧ Operate the transceiver normally.
- ⑨ To cancel the EMR communication mode, select "OFF" in EMR at step ⑥.

## 5 DV MODE OPERATION (Optional UT-123 is required)

### ■ Low-speed data communication

In addition to the digital voice communication, low-speed data communication is available.

The optional OPC-1529R DATA COMMUNICATION CABLE and serial data communication software (purchase locally) are required in addition.

/// **NOTE:** Turn OFF the GPS data communication (p. 127) in advance to operate the low-speed data communication.

#### ◇ Connection

Connect the transceiver to your PC using with the optional OPC-1529R as illustrated below.

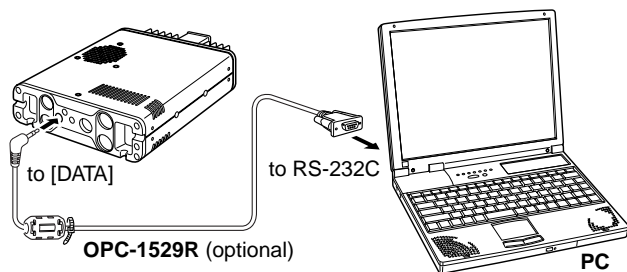

#### ◇ Low-speed data communication application setting

Configure the low-speed data communication application as follows.

- Port : The same COM port number as IC-2820H's
- Baud rate : 9600 bps (fixed value)
- Data : 8 bit
- Parity : None
- Stop : 1 bit
- Flow control : Xon/Xoff

#### ◇ Low-speed data communication operation

/// **NOTE:** Confirm that in AUTO, the computer controls when [PTT] is active, so that you can send data without pressing [PTT] on the radio.

- ① Set your own, station call signs, etc. as described in “■ Digital voice mode operation” (p. 39) and “■ Digital repeater operation” (p. 42).
- ② Refer to the instructions for the low-speed data communication application.
- ③ To transmit data.
  - At the same time as voice audio, push and hold [PTT] to transmit while sending data from the PC. Release [PTT] to receive.
  - Under computer control, see Transmission condition setting at right.

◆ **Transmission condition setting**

- ① Push **[F••••]** to display the function guide.
- ② Push **[MENU](V/MHz•SCAN)** (Right band's) to display the "MENU" screen.
- ③ Rotate **[DIAL]** to select "DV SET MODE," then push **[MAIN•BAND]**.
- ④ Rotate **[DIAL]** to select "DV DATA TX," then push **[MAIN•BAND]**.
- ⑤ Rotate **[DIAL]** to select the desired transmission condition.

**PTT** : The entered text data in the Terminal Window (buffer screen) is transmitted when [PTT] is pushed. (default)

**AUTO** : The entered text data in the Terminal Window (buffer screen) is automatically transmitted when text is entered.

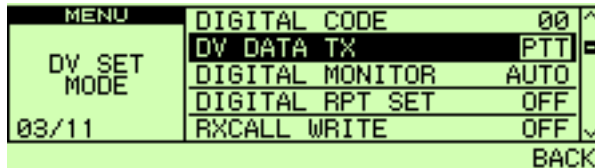

- ⑥ Push **[BACK](V/MHz•SCAN)** (Right band's) three times to exit from DV set mode screen.

■ **DV voice memory**

The IC-2820H has a DV voice memory that records a total of 30 sec. (approx.) of received audio.

The DV voice memory is divided into 2 tracks, 15 seconds each in a track, as the default setting.

◆ **Recording received audio**

- ① Select DV mode in main band, and deactivate the priority watch (p. 81) and weather alert function (p. 123) if activated.
- ② While receiving a DV signal, push **[F••••]** twice to display the function guide 2.
- ③ Push **[REC](M/CALL•MW)** (Right band's) to display the REC track screen.
- ④ Rotate **[DIAL]** to select the desired track.
  - Bar meter is displayed for the track that has been recorded.

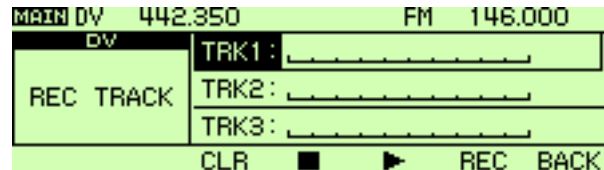

- ⑤ Push **[REC](M/CALL•MW)** (Right band's) to start recording.
  - Track counter (bar meter) is displayed during record.
  - The recording is paused automatically when the DV signal is interrupted or when the DV audio signal cannot be received correctly. Re-starts the recording when the DV audio signal is received correctly.
- ⑥ Push **[■](TONE•DTMF)** to stop recording.
  - The recording stops automatically when the track becomes full.

## 5 DV MODE OPERATION (Optional UT-123 is required)

### ◆ Track size setting

The track size can be changed with the following instruction.

- ① Push [**F**•**→**] to display the function guide.
- ② Push [**MENU**](V/MHz•SCAN) (Right band's) to display the MENU screen.
- ③ Rotate [**DIAL**] to select "DV VOICE MEMO" then push [**MAIN•BAND**].
- ④ Rotate [**DIAL**] to select "TRACK SIZE" then push [**MAIN•BAND**].

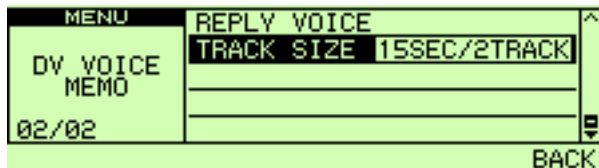

- ⑤ Rotate [**DIAL**] to select the desired track size.
  - 10SEC/3TRACK** : Makes 3 tracks and 10 seconds audio can be recorded in each track.
  - 15SEC/2TRACK** : Makes 2 tracks and 15 seconds audio can be recorded in each track. (default)
  - 30SEC/1TRACK** : Makes 1 track only and 30 seconds audio can be recorded in a track.
- ⑥ Push [**MAIN•BAND**] to set the track size.
- ⑦ Push [**BACK**](V/MHz•SCAN) (Right band's) twice to exit from DV voice memo screen.

### ◆ Playing-back and erasing the recorded audio

- ① Push [**F**•**→**] twice to display the function guide 2.
- ② Push [**REC**](M/CALL•MW) (Right band's) to enter REC track screen.
- ③ Rotate [**DIAL**] to select the desired audio track to be played back or erased.
  - "\*" is displayed beside the track number when the selected track has been recorded.
- ④ Push [**▶**](LOW•PRIO) to play-back the recorded audio.
  - Push [**|||**](LOW•PRIO) to pause, push [**■**](TONE•DTMF) to stop play-back.

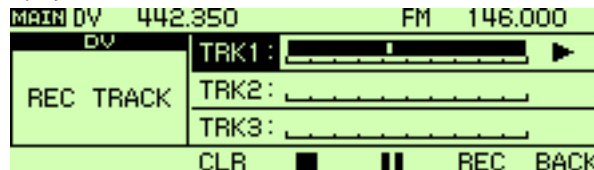

- ⑤ Push [**CLR**](DUP•MONI) to erase the recorded audio.
- ⑥ Push [**BACK**](V/MHz•SCAN) (Right band's) to return to frequency indication.

## ■ DV automatic detect

The “DV” mode indicator blinks when a non-DV signal is received during DV mode operation.

The IC-2820H DV automatic detection monitors in FM mode when other than DV mode signal is received.

- ① Push [**F**•**—**•**o**] to display the function guide.
- ② Push [**MENU**](V/MHz•SCAN) (Right band's) to display the MENU screen.
- ③ Rotate [**DIAL**] to select “DV SET MODE” then push [**MAIN**•**BAND**].
- ④ Rotate [**DIAL**] to select “DV AUTO DETECT” then push [**MAIN**•**BAND**].

MENU	RXCALL WRITE	OFF	^
	RXRPT WRITE	OFF	
DV SET MODE	DV AUTO DETECT	OFF	■
	EDIT RECORD	AUTO	
08/11	EMR	OFF	v
	BACK		

- ⑤ Rotate [**DIAL**] to turn the DV automatic detect function ON and OFF, then push [**MAIN**•**BAND**].
  - OFF** : “DV” mode indicator blinks, however the transceiver receives in DV mode even if non-DV mode signals are received. (default)
  - ON** : “DV” mode indicator blinks and the transceiver monitors the signal in FM mode.
- ⑥ Push [**BACK**](V/MHz•SCAN) (Right band's) twice to exit from DV set mode.

/// **NOTE:** The received FM audio may be distorted when receiving an FM signal with the DV automatic detect function active.

## ■ General description

The transceiver has 522 memory channels, including 20 scan edge memory channels (10-pairs) and 2 call channels. Each of these channels can be individually programmed with operating frequency (pgs. 15–17), duplex direction (p. 30) and offset (p. 34), subaudible tone encoder or tone squelch and its tone frequency (pgs. 32, 86–88) and skip information (p. 79).

In addition, a total of 26 memory banks, A to Z, are available for usage by group, etc.

## ■ Memory channel selection

### ◇ Using the tuning dial

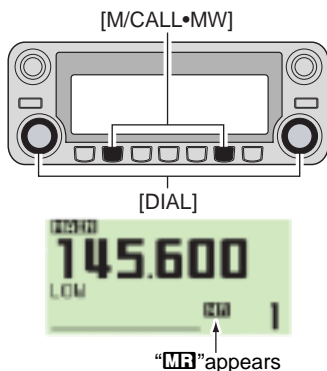

- 1 Push the desired band's **[M/CALL•MW]** several times to select memory mode.
  - “MR” indicator appears.
- 2 Rotate the same band's **[DIAL]** to select the desired memory channel.
  - Programmed memory channels only can be selected.

### ◇ Using the [▲]/[▼] keys



- 1 Push [BAND] to select the desired band as the main band.
- 2 Push [MR/CALL] to select memory mode.
- 3 Push [▲] or [▼] to select and set the desired memory channel.
  - Pushing and holding [▲]/[▼] for 1 sec. activates a scan.
  - If scan is activated, push [▲]/[▼] again or push [CLR A(MW)] to stop it.

### ◇ Using the keypad

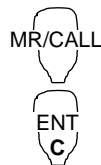

- 1 Push [BAND] to select the desired band as the main band.
- 2 Push [MR/CALL] to select memory mode.
- 3 Push [ENT C(T-OFF)] to activate the keypad for numeral input.
- 4 Push 3 appropriate digit keys to input a channel number.
  - Blank channel can be selected.
  - Push only 1 appropriate digit key, [VOL▲ 0(TONE-2)] to [SIMP 9(16-KEY-L)] then push [\* (TONE-1)] or [SQL▼ # (16KEY-L)] to select scan edge channels. “\*” and “#” can be used for “A” and “B” respectively.

## ■ Programming a memory channel

VFO settings, including MENU group contents such as sub-audible tone frequency and offset can be programmed into a memory channel.

- ① Set the desired frequency in the desired band (left or right).
  - ➔ Push the desired band's **[V/MHz•SCAN]** to select VFO mode.
  - ➔ Set the frequency using the same band's **[DIAL]**.
  - ➔ Set other data (e.g. tone frequency, duplex information, etc.) if required.
- ② Push and hold the same band's **[M/CALL•MW]** for 1 sec.
  - 2 beeps sound
  - "MR" indicator and the memory channel number blink.

- ③ Rotate the **[DIAL]** to select the memory channel to be programmed.
  - Memory channels not yet programmed are blank.
- ④ Push and hold **[S.MW](M/CALL•MW)** (Left band's) for 1 sec. to program.
  - 3 beeps sound
  - Memory channel number automatically increases when continuing to push **[M/CALL•MW]** after programming.

**✓ FOR YOUR CONVENIENCE**

Memory programming can be performed in various ways e.g. memory channel to the same (or different) memory channel, memory channel to the call channel, etc.

**[EXAMPLE]:** Programming 145.870 MHz into memory channel 20 (blank channel) via the controller.

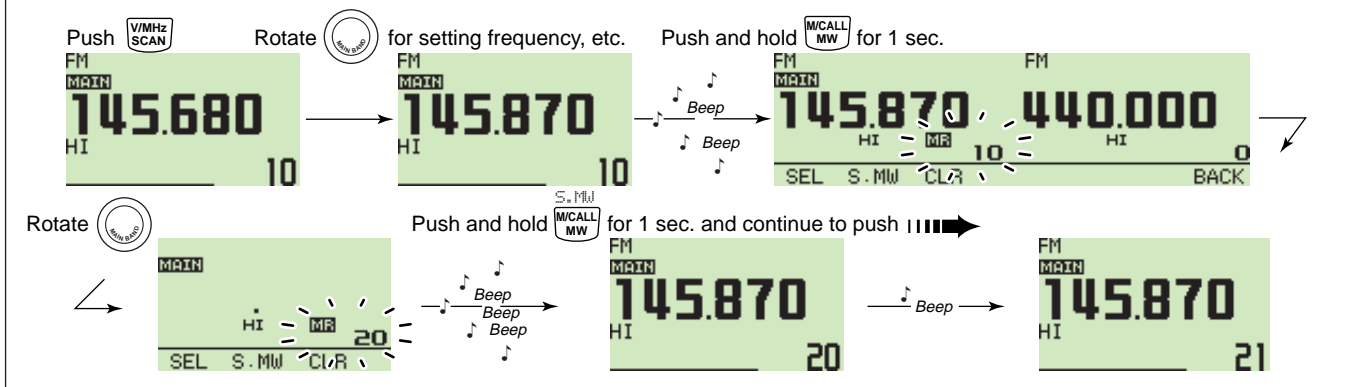

## 6 MEMORY MODE OPERATION

### ◇ Programming a memory channel via the microphone

 The microphone can also be used to program memory channels.

- 1 Set the desired frequency in VFO mode.
  - Push [VFO/LOCK] to select VFO mode.
  - Set the frequency using the keypad.
  - Set other data (e.g. offset frequency, duplex direction, sub-audible tone encoder ON/OFF and its frequency), if necessary.
- 2 Push [MR/CALL] to enter memory mode.
- 3 Push [ENT C(T-OFF)], then set the desired memory channel using the keypad.
- 4 Push [VFO/LOCK] to select VFO mode.
- 5 Push [FUNC] then push and hold [CLR A(MW)] for 1 sec. to program.
  - 3 beeps may sound and the VFO contents (including the subaudible tone frequency, etc.) are programmed.
  - Memory channel number increases when continuing to push [CLR A(MW)] after programming.

**[EXAMPLE]:** Programming 145.870 MHz into memory channel 20 (blank channel) via the microphone.

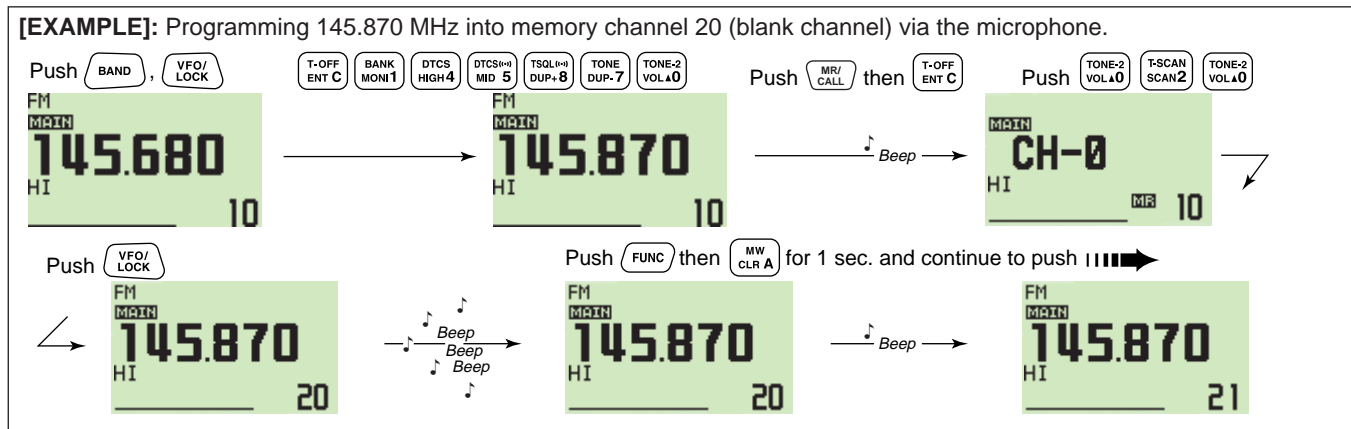

## ■ Memory bank selection

The IC-2820H has a total of 26 banks (A to Z). All memory channels, regular channels, scan edges and call channels are assigned into the desired bank for easy memory management.

- ① Push the desired band's **[M/CALL•MW]** several times to select memory mode, if desired.
- ② Push and hold the same band's **[MAIN•BAND]** for 1 sec.
  - The memory channel number blinks.
- ③ Rotate the same band's **[DIAL]** to select the desired bank, A to Z.
  - Banks that have no programmed contents are skipped.
- ④ Push the same band's **[MAIN•BAND]** to set the bank group.
  - Bank initial and bank channel stop blinking.
- ⑤ Rotate the same band's **[DIAL]** to select the desired bank channel.
- ⑥ To return to regular memory mode, push and hold the same band's **[MAIN•BAND]** for 1 sec., rotate the same band's **[DIAL]** to select memory channel number indication, then push the same band's **[MAIN•BAND]**.

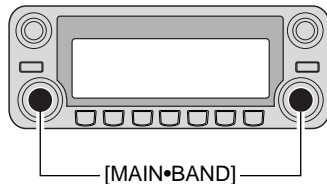

Bank initial and bank channel blink



① Push **[MR/CALL]** to select memory mode, if desired.

② Push **[FUNC]** then **[MONI 1(BANK)]** to select memory bank condition.

Or, push and hold **[BAND]** for 1 sec. to select memory bank condition.

- Memory channel blinks

③ Push **[▲]/[▼]** to select the desired bank, A to Z.

- Only programmed memory bank can be selected.

④ Push **[CLR A(MW)]** to set the bank.

Or, push **[BAND]** to set the bank.

- Bank initial and bank channel stops blinking.

⑤ Push **[▲]/[▼]** to select the desired contents in the bank.

⑥ To return to regular memory condition, push **[FUNC]**, **[MONI 1(BANK)]** then push **[▲]/[▼]** to select memory channel number indication.

Or, push and hold **[BAND]** for 1 sec., then push **[▲]/[▼]** to select memory channel number indication.

## 6 MEMORY MODE OPERATION

### ■ Memory bank setting

- ① Push the desired band's **[M/CALL•MW]** several times to select memory mode, then rotate the same band's **[DIAL]** to select the desired memory channel.
  - "MR" and memory number indication blinks.
- ② Push and hold the same band's **[M/CALL•MW]** for 1 sec.
  - "MR" and memory number indication blinks.
- ③ Push **[SEL](V/MHz•SCAN)** (Left band's) once to select "BANK" setting stand-by condition.
  - "MR" indicator blinks.
- ④ Push **[EDIT](M/CALL•MW)** (Right band's) to edit.
  - "MR" and 1st digit blink.

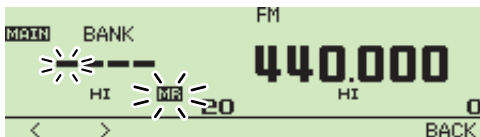

- ⑤ Rotate the same band's **[DIAL]** to select the desired bank group.
  - A to Z bank groups available.
- ⑥ Push **[>](M/CALL•MW)** (Left band's) then rotate **[DIAL]** to select the desired bank channel.
  - "MR" and last 2 digits blink.

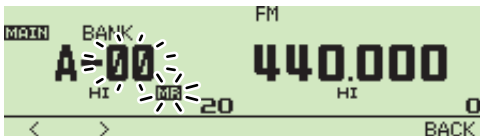

- ⑦ Push **[BACK](V/MHz•SCAN)** (Right band's) to set the bank initial and channel number.
  - "MR" indicator blinks.
- ⑧ Push and hold **[S.MW](M/CALL•MW)** (Left band's) for 1 sec. to overwrite the memory channel to store the memory bank settings.
- ⑨ Repeat steps ① to ⑧ to set another memory channel into the same or another bank.

## ■ Programming memory/bank/scan name

Each memory channel can be programmed with an alphanumeric channel name for easy recognition and can be indicated independently by channel. Names can be a maximum of 8 characters— see the following table for available characters.

- ① Select the desired memory channel to be programmed.
  - ➔ Push **[M/CALL•MW]** several times to select memory mode, then rotate the same band's **[DIAL]** to select the desired memory channel.
- ② Push and hold the same band's **[M/CALL•MW]** for 1 sec. to enter select memory write mode.
  - “**MEM**” indicator and the memory channel number blink.
- ③ Push **[SEL](V/MHz•SCAN)** (Left band's) several times to select programming the name conditions.
  - “**BANK**” : The memory bank
  - “**B NAME**” : The bank name (appears only when the selected memory bank is edited into a bank)
  - “**M NAME**” : The memory name
  - “**S NAME**” : The scan name (appears only when a scan edge channel is selected)
  - Frequency readouts disappear.
- ④ Push **[EDIT](M/CALL•MW)** (Right band's) to edit.
  - “**MEM**” indicator and cursor blinks.
- ⑤ Rotate the same band's **[DIAL]** to select the desired character.
  - The selected character blinks.
  - Push **[Aa](TONE•DTMF)** to select the character group from capital letter characters or lower case letters.

- Push **[1/](M/CALL•MW)** (Right band's) to select the character group from numbers or symbols.
- Push **[>](M/CALL•MW)** (Left band's) to move the cursor right; push **[<](V/MHz•SCAN)** (Left band's) to move the cursor left.
- Push **[CLR](DUP/MONI)** to clear the selected character.
- Push and hold **[CLR](DUP/MONI)** for 1 sec. to clear all characters after the selected character.

- ⑥ Repeat steps ③ and ⑤ until the desired channel name is programmed.
- ⑦ Push **[BACK](V/MHz•SCAN)** (Right band's) to set the name.
- ⑧ Push and hold **[S.MW](M/CALL•MW)** (Right band's) for 1 sec. to overwrite the memory channel to store the memory name.

**NOTE:** Only one bank name can be programmed into each bank. Therefore, the previously programmed bank name will be displayed when bank name indication is selected. Also, the programmed bank name is assigned for the other bank channels automatically.

### ◇ Available characters

ABCDEFGHIJKLMNOPQRSTUVWXYZ
abcdefghijklmnopqrstuvwxyz
0123456789
(Space)! " # \$ % & ' ( ) * + , -
. / : ; < = > ? @ [ \ ] ^ _ ` {   } ~

## 6 MEMORY MODE OPERATION

**[EXAMPLE]:** Programming the bank name “AIR” into the scan edge channel 3A.

Memory mode  
 Push **[M/CALL MW]** (Main band's) to select memory mode.

Rotate **[DIAL]** (Main band's) to select scan edge channel 3A.

Push and hold **[M/CALL MW]** (Main band's) for 1 sec. to enter select memory write condition.

Select memory write mode

Bank name edit mode

Push **[SEL V/MHz SCAN]** (Main band's) several times to select “B NAME”.

Push **[EDIT M/CALL MW]** (Right band's) to enter bank name edit mode.

Rotate **[DIAL]** (Main band's) to select “A”, then push **[M/CALL MW]**.

Enter “I” and “R” with **[DIAL]** (Main band's) and **[M/CALL MW]** (Left band's), then push **[BACK V/MHz SCAN]** (Right band's) to select memory write mode.

Push and hold **[S. Hld M/CALL MW]** (Left band's) for 1 sec. to program.

\*Select “M NAME” or “S NAME” when programming the memory name or the scan name, respectively.

### ◆ To indicate the channel name

The channel name indication can be set independently for each memory channel.

- ① Select the desired memory channel in the main band.
  - ➔ Push the same band's **[M/CALL•MW]** several times to select memory mode, then rotate the same band's **[DIAL]** to select the desired memory channel.
    - “M” and memory channel number appear.
- ② Push **[F••••]** to display the function guide.

- ③ Push **[M.N](LOW•PRIO)** several times to select “MEMORY NAME,” “FREQUENCY” or OFF.
  - When “MEMORY NAME” is selected, the programmed memory name is indicated above frequency indication; when “FREQUENCY” is selected, the programmed memory name is indicated at the frequency indication and the programmed frequency is indicated above the memory name.
- ④ Push **[F••••]** twice to exit the function guide indication.

**NOTE:** When no memory name is programmed, the stored frequency is displayed.

## ■ Copying memory contents

This function copies a memory channel's contents to VFO (or another memory/call channel). This is useful when searching for signals around a memory channel frequency and for recalling the offset frequency, subaudible tone frequency etc.

### ◇ Memory/call↔VFO

- ① Select the desired band's (left or right) memory or call channel.
  - ➡ Push the desired band's **[M/CALL•MW]** several times to select memory mode or call channel, then rotate the same band's **[DIAL]** to select the desired memory or call channel.
- ② Push and hold **[M/CALL•MW]** for 2 sec. to copy the selected memory/call channel contents to the VFO.
  - VFO mode is selected automatically.



- ① Push **[BAND]** to select the desired band as the main band, if necessary.
- ② Select the memory/call channel to be copied.
  - ➡ Push **[MR/CALL]** to select memory mode, then select the desired memory channel via **[▲]/[▼]** or keypad.
  - ➡ Push and hold **[MR/CALL]** for 1 sec. then push **[▲]/[▼]** to select the call channel.
- ③ Push **[FUNC]**, then push and hold **[CLR A(MW)]** for 1 sec. to copy the selected memory/call channel contents to the VFO.
  - VFO mode is selected automatically.

6

**[EXAMPLE]:** Copying memory channel 30 contents to VFO.

**Front panel operation:**

Push **[M/CALL MW]** to select memory mode. Rotate **[DIAL]** for selecting memory channel. Push and hold **[M/CALL MW]** (same band's) for 1 sec.

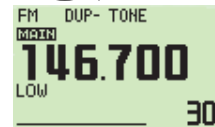
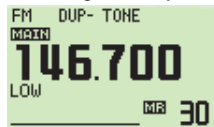
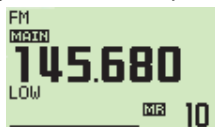

**HM-133 operation:**

Push **[MR/CALL]** to select memory mode. Select memory channel. Push **[FUNC]** then push and hold **[MW CLR A]** for 1 sec.

## 6 MEMORY MODE OPERATION

### ◇ Memory/call↔call/memory

- ① Select the memory/call channel to be copied.
  - ➔ Push the desired band's **[M/CALL•MW]** several times to select memory mode or call channel, then rotate the same band's **[DIAL]** to select the desired memory or call channel.
- ② Push and hold the same band's **[M/CALL•MW]** for 1 sec.
  - “**MR**” indicator and the memory channel number blink.
- ③ Rotate the same band's **[DIAL]** to select the target memory channel.
  - “C1” or “C2” blinks when the call channel is selected.
  - Scan edge channels, 0A/0B to 9A/9B can also be selected.
- ④ Push and hold the **[S.MW](M/CALL•MW)** (Left band's) for 1 sec. to copy the selected memory/call channel contents to the target memory.
  - The targeted memory and copied contents are indicated.

**[EXAMPLE]:** Copying memory channel 30 contents to channel 31.

Select the memory channel,

then push and hold  for 1 sec.

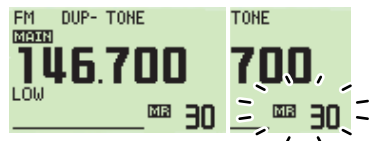

Select the target channel.



Push and hold  for 1 sec.

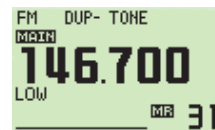

## Memory clearing

Contents of programmed memories can be cleared (blanked), if desired.

- ① Push **[V/MHz•SCAN]** to select VFO mode in the desired band (left or right).
- ② Push and hold the same band's **[M/CALL•MW]** for 1 sec.
  - “**MR**” indicator and the memory channel number blink.
- ③ Rotate **[DIAL]** to select the memory channel to be cleared.
- ④ Push and hold **[CLR](DUP•MONI)** for 1 sec. to clear.
  - 3 beeps sound, then the frequency is cleared.
  - “**MR**” indicator and the channel number blink continuously.
  - When clearing the call channel, the current VFO conditions are re-programmed into the call channel automatically.

- ⑤ Push **[BACK](V/MHz•SCAN)** (Right band's) to return to VFO mode.

**NOTE:** Be careful!— the contents of cleared memories **CANNOT** be recalled.

**[EXAMPLE]:** Clearing memory channel 20.

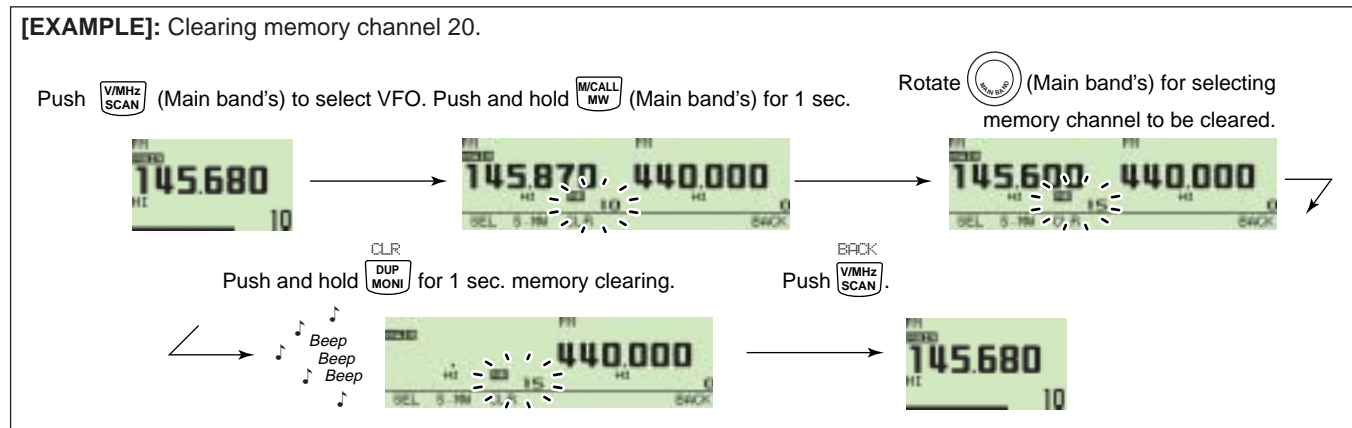

### ■ Erasing/transferring bank contents

Contents of programmed memory banks can be cleared or transferred to another bank.

**INFORMATION:** Even if the memory bank contents are cleared, the memory channel contents still remain programmed.

- ① Select the desired bank contents to be transferred or erased from the band (left or right).
  - ➔ Push the desired band's **[M/CALL•MW]** several times to select memory mode.
  - ➔ Push and hold the same band's **[MAIN•BAND]** for 1 sec. then rotate the same band's **[DIAL]** to select the desired memory bank.
    - Bank initial and bank channel stops blinking.
  - ➔ Push the **[MAIN•BAND]** to select the bank then rotate the **[DIAL]** to select the desired bank channel.
    - Bank initial and bank channel stops blinking.
- ② Push and hold the same band's **[M/CALL•MW]** for 1 sec.
  - "MB" indicator and the memory channel number blink



- ③ Push **[SEL](V/MHz•SCAN)** (Left band's) several times to select BANK, then push **[EDIT](M/CALL•MW)** (Right band's).

- ④ Rotate **[DIAL]** to select the desired bank initial (A to Z) to transfer.
  - Select no indication, "----," when erasing the contents from the bank.
- ⑤ Push **[>](M/CALL•MW)** (Left band's) then rotate the same band's **[DIAL]** to select a bank channel, if desired.
- ⑥ Push **[BACK](V/MHz•SCAN)** (Right band's) to return to the select memory write mode.
- ⑦ Push and hold **[S.MW](M/CALL•MW)** (Left band's) for 1 sec. to be transferred or erased.
- ⑧ Repeat steps ① to ⑤ for transferring or erasing an another bank's contents.

## ■ Call channel selection

Call channel is a pre-programmed memory channel that can be accessed by simply pushing call channel button.

- ➔ Push the desired band's **[M/CALL•MW]** several times to select the call channel mode, then rotate the same band's **[DIAL]** to select the desired call channel.
  - “C0” or “C1” appears instead of memory channel number.
  - Push the **[M/CALL•MW]** several times to select memory mode, or push the same band's **[V/MHz•SCAN]** to select VFO mode.

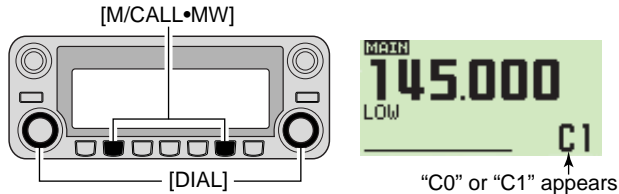

- ➔ Push and hold **[MR/CALL]** for 1 sec. to select the call channel mode then push **[▲]/[▼]** to select the desired call channel in the main band.
  - Push **[MR/CALL]** to select memory mode, or push **[VFO/LOCK]** to select VFO mode.

### ✓ INFORMATION



When the VFO mode is selected from the call channel, a small “c” appears instead of memory channel number.

## ■ Call channel copying

### ◇ Call → VFO/Memory

- ① Push the desired band's **[M/CALL•MW]** several times to select call channel mode, then rotate the same band's **[DIAL]** to select the desired call channel.
  - “C0” or “C1” appears.
- ② Push the same band's **[M/CALL•MW]** for 1 sec., then rotate the **[DIAL]** to select the memory channel to copy the contents to.
  - “**MB**” indicator and memory channel number blink.
  - To copy to the VFO mode, select “VFO” with the **[DIAL]**.
- ③ Push and hold the same band's **[M/CALL•MW]** for 1 sec. to copy the contents.

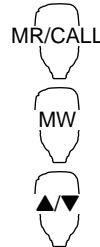

- ① Push **[MR/CALL]** for 1 sec. then push **[▲]/[▼]** to select the desired call channel in the main band.
- ② Push **[FUNC]**, then **[CLR A(MW)]** for 1 sec. to copy the contents.
  - To copy to the VFO only.

## ■ Programming a call channel

Operating frequency, duplex information, subaudible tone information (tone encoder or tone squelch ON/OFF and its frequency) can be programmed into the call channel.

- ① Set the desired frequency in VFO mode.
  - ➔ Push the desired band's **[V/MHz•SCAN]** to select VFO mode.
  - ➔ Set the frequency using the same band's **[DIAL]**.
  - ➔ Set other data as desired.
- ② Push and hold the same band's **[M/CALL•MW]** for 1 sec.
- ③ Rotate the same band's **[DIAL]** to select the desired call channel.
  - "MR" indicator and "C0" or "C1" blink.

- ④ Push the same band's **[M/CALL•MW]** for 1 sec. to program.
  - 3 beeps sound and the unit returns to VFO mode automatically.

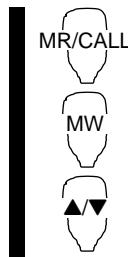
- 
- ① Push and hold **[MR/CALL]** for 1 sec. to select call channel mode.
    - ➔ Push **[▲]** or **[▼]** to select desired call channel.
  - ② Push **[VFO/LOCK]** to select VFO mode.
    - ➔ Set the frequency.
  - ③ Push **[FUNC]** then **[CLR A(MW)]** for 1 sec. to program.
    - 3 beeps sound.

**[EXAMPLE]:** Programming 145.120 MHz into the call channel 1 via the microphone.

Push and hold **[MR/CALL]** for 1 sec. to select call channel mode.

Push **[▲/▼]** to select the call channel "C1".

Push **[VFO/LOCK]** to select VFO mode.

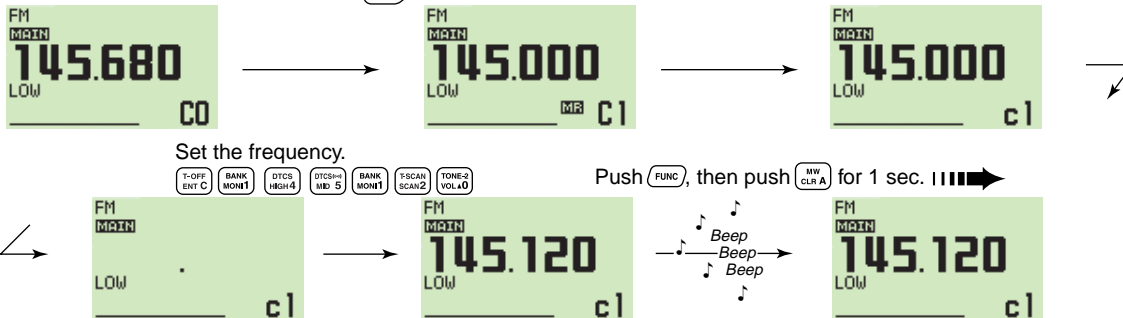

## ■ Scan types

Scanning searches for signals automatically and makes it easier to locate new stations for contact or listening purposes.

There are 4 scan types and 4 resume conditions to suit your operating needs.

### FULL SCAN (p. 75)

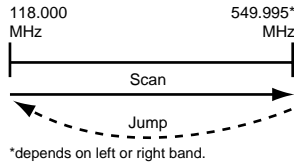

Repeatedly scans all frequencies over the entire band.

Some frequency ranges are not scanned according to the frequency coverage of the transceiver's version.

### MEMORY (SKIP) SCAN (p. 75)

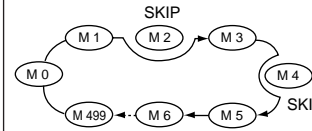

Repeatedly scans memory channels except those set as skip channel. Skip channels can be turned ON and OFF in function guide.

### PROGRAMMED SCAN (p. 75)

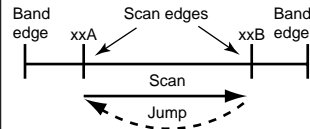

Repeatedly scans between two user-programmed frequencies. Used for checking for frequencies within a specified range such as repeater output frequencies, etc.

### ALL/SELECTED BANK SCAN (p. 75)

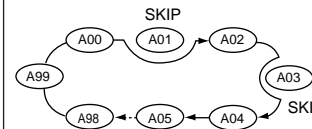

Repeatedly scans all bank channels or selected bank channels. The skip scan is also available.

### FREQUENCY/MEMORY SKIP FUNCTION (p. 79)

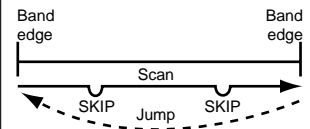

Skips unwanted frequencies or channels that inconveniently stop scanning. This function can be turned ON and OFF by pushing **[SKIP](TONE•DTMF)** in memory mode.

## ■ Scan start/stop

### ◇ Preparation

Scan resume condition (p. 78); program the scan edges (pgs. 76, 77); program 2 or more memory channels (pgs. 62, 63); set skip settings, if desired (p. 79).

### ◇ Operation

- ① Select VFO mode for full/programmed scan with **[V/MHz•SCAN]**; or memory mode for memory scan with **[M/CALL•MW]** in the desired band (Left or Right).
  - Select the desired bank with the same band's **[MAIN•BAND]** for bank scan.
- ② Push and hold the same band's **[V/MHz•SCAN]** for 1 sec.
- ③ Rotate the same band's **[DIAL]** to select the scan type from ALL and programmed scan (PROG 0 to PROG 9), if VFO is selected in step ①.
- ④ Push the same band's **[V/MHz•SCAN]** momentarily to start the scan.
  - To change the scanning direction, rotate the same band's **[DIAL]**.
  - The memory channel readout blinks the scan type as follows:

#### • During full scan



Rotate **[DIAL]** to select "ALL" (full) or programmed scan (P1 to P9) in sequence.

#### • During programmed scan



Indicates scan edge channels.  
• P1 stands for 1A/1B

#### • During memory scan



#### • During bank scan



Indicates bank initial.

- ⑤ To stop the scan, push the same band's **[V/MHz•SCAN]**.



- ① Push **[VFO/LOCK]** to select VFO mode for full/programmed scan; push **[MR/CALL]** to select memory mode for memory scan, in the main band.
  - Push **[FUNC]** then **[MONI 1(BANK)]** to select a bank for bank scan.
- ② Push **[SCAN 2(T-SCAN)]**.
- ③ Push **[▲]** or **[▼]** to select the ALL and programmed scan (PROG 0 to PROG 9), if VFO is selected in step ①.
- ④ Push **[SCAN 2(T-SCAN)]** again to start the scan.
  - Push **[▲]** or **[▼]** for 1 sec. also starts the scan.
- ⑤ To stop the scan push **[SCAN 2(T-SCAN)]** or **[CLR A(MW)]**.

## ■ Scan edges programming

Scan edges can be programmed in the same manner as memory channels. Scan edges are programmed into scan edges, 0A/0B to 9A/9B, in memory channels.

- ① Set the edge frequency of the desired frequency range in VFO mode:
  - ➔ Set the frequency using the desired band's [DIAL].
  - ➔ Set other data (e.g. repeater settings, etc.) if desired.
- ② Push the same band's [M/CALL•MW] for 1 sec.
  - "MR" indicator and channel number blink.
- ③ Rotate the same band's [DIAL] to select one of scan edge channel, 0A to 9A.

- ④ Push and hold [S.MW](M/CALL•MW) (Left band's) for 1 sec. to program.
  - 3 beeps sound and VFO is automatically selected.
  - Scan edge 0B to 9B is automatically selected when continuing to push the [M/CALL•MW] after programming.
- ⑤ To program a frequency for the other pair of scan edges, 0B to 9B, repeat steps ① and ④.
  - If the same frequency is programmed into a pair of scan edges, programmed scan will not function.

**[EXAMPLE]:** Programming 145.300 MHz into scan edges 1A.

Push to select VFO mode. Rotate for setting frequency, etc. Push and hold for 1 sec.

Rotate Push and hold (Left band's) for 1 sec. and continue to push

## 8 SCAN OPERATION

### ◇ Programming scan edges via microphone



1 Push [MR/CALL] to select memory mode.

2 Select scan edge channel, 0A to 9A using [▲]/[▼] or keypad.

- Push [ENT C(T-OFF)] then push only 1 appropriate digit key, [VOL▲ 0(TONE-2)] to [SIMP 9(16-KEY-L)] then push [\*\*(TONE-1)] or [SQL▼ #(16KEY-L)] to select scan edge channels. "\*" and "#" can be used for "A" and "B" respectively.

3 Set the desired frequency in VFO mode.

- ➔ Push [VFO/LOCK] to select VFO mode.
- ➔ Set the frequency via the keypad or [▲]/[▼].

4 Push [FUNC], then push and hold [CLR A(MW)] for 1 sec. to program.

- 3 beeps sound and VFO is automatically selected.
- Memory channel number advances to the next scan edge channel, 1B to 9B when continuing to push [CLR A(MW)] after programming.

5 To program a frequency for the other scan edge channels, repeat steps 1 to 4.

[EXAMPLE]: Programming 145.800 MHz into scan edge 4A.

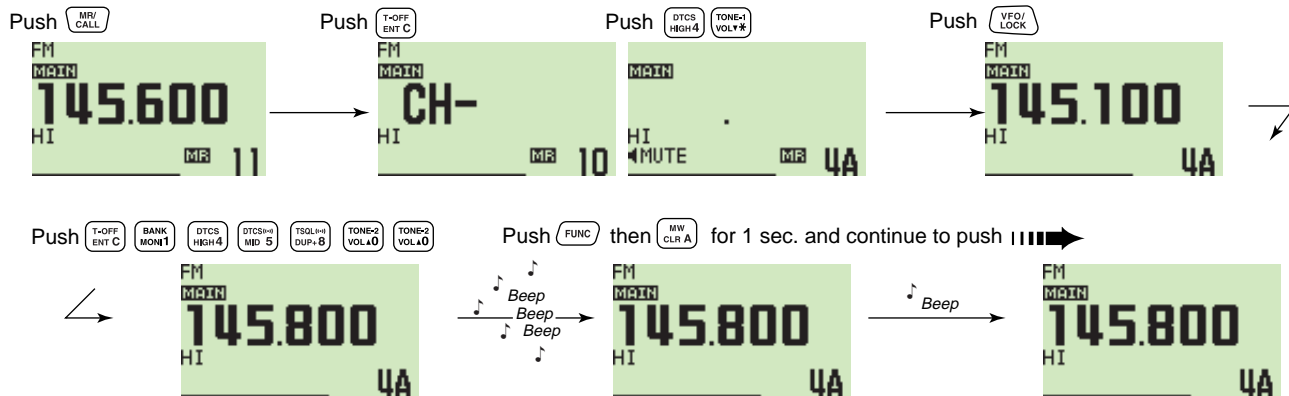

## ■ Scan resume condition

The scan resume condition can be selected as timer or pause scan. The selected resume condition is also used for priority watch. (p. 81)

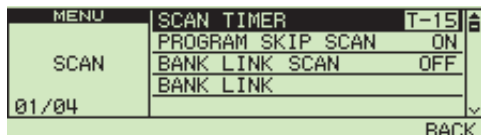

The display shows that the scan will resume 15 sec. after it stops.

- ① Push **[MAIN•BAND]** to select the desired band (left or right) as the main band.
- ② Push **[F••••]** to display the function guide.
- ③ Push **[MENU](V/MHz•SCAN)** (Right band's) to enter MENU screen.
- ④ Rotate the **[DIAL]** to select "SCAN," then push **[MAIN•BAND]**.
- ⑤ Rotate the main band's **[DIAL]** to select "SCAN TIMER," then push **[MAIN•BAND]**.
- ⑥ Rotate **[DIAL]** to select the desired timer:
  - "T-5" : Scan pauses 5 sec. while receiving a signal.
  - "T-10" : Scan pauses 10 sec. while receiving a signal.
  - "T-15" : Scan pauses 15 sec. while receiving a signal.
  - "P-2" : Scan pauses until the signal disappears and then resumes 2 sec. later.
- ⑦ Push **[MAIN•BAND]** to set.
- ⑧ Push **[BACK](V/MHz•SCAN)** (Right band's) twice to return to frequency indication.



- ① Push **[BAND]** to select the desired band (left or right) as the main band.
- ② Push **[SET B(D-OFF)]** to enter MENU screen.
- ③ Push **[▲]** or **[▼]** to select "SCAN" then push **[SET B(D-OFF)]** to enter scan set mode.
- ④ Push **[▲]** or **[▼]** to select "SCAN TIMER" then push **[SET B(D-OFF)]**.
- ⑤ Push **[▲]** or **[▼]** to select the scan resume condition, then push **[SET B(D-OFF)]**.
  - See item ⑥ at left for scan resume condition details.
- ⑥ Push **[CLR A(MW)]** to exit set mode.

### ■ Skip channel setting

The memory skip function speeds up scanning by checking only those memory channels not set as skip channels. Set skip channels as follows.

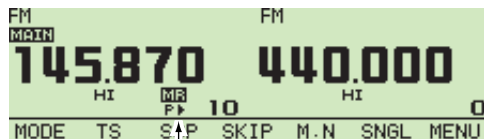

Skip indicator appears

- ① Select a memory channel in the desired band (Left or Right):
  - ➔ Push the desired band's **[M/CALL•MW]** to select memory mode.
  - ➔ Rotate the same band's **[DIAL]** to select the desired channel to be a skip channel.
- ② Push **[F••••]** to display the function guide.
- ③ Push **[SKIP](TONE•DTMF)** to select the skip condition from “▶”, “P▶” or “OFF (no indication)” for the selected channel.
  - “▶” (SKIP) : The channel is skipped during memory or bank scan.
  - “P▶” (PSKIP): The channel is skipped during memory/bank scan and the programmed scan.
  - “\_” (OFF) : The channel is scanned during any scan.
- ④ Push **[F••••]** once or twice to exit the function guide indication.

## ■ Priority watch types

Priority watch checks for signals on a VFO frequency every 5 sec. while operating in memory mode. The transceiver has 3 priority watch types to suit your needs. You can also transmit on the VFO frequency while the priority watch operates.

The watch resumes according to the selected scan resume condition. See page 78 for details.

### NOTE:

If the pocket beep function is activated, the transceiver automatically selects the tone squelch function when priority watch starts.

### MEMORY CHANNEL WATCH

While operating on a VFO frequency, priority watch checks for a signal on the selected memory channel every 5 sec.

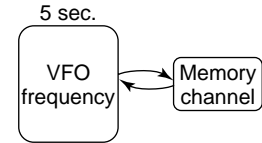

### MEMORY SCAN WATCH

While operating on a VFO frequency, priority watch checks for signals on each memory channel in sequence.

- The memory skip function is useful to speed up the scan.

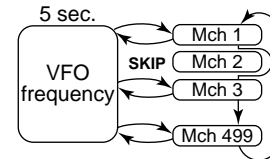

### CALL CHANNEL WATCH

While operating on a VFO frequency, priority watch checks for signals on the call channel every 5 sec.

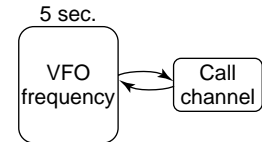

### ■ Priority watch operation

- ① Select VFO mode, then set an operating frequency in the desired MAIN band (left or right).
- ② Set the watched channel(s).

**For memory channel watch:**

Select the desired memory channel.

**For memory scan watch:**

Select memory mode; then, push and hold the main band's [V/MHz•SCAN] for 1 sec. to start memory scan.

**For call channel watch:**

Select the desired call channel by pushing the main band's [M/CALL•MW] once or twice, then rotate the [DIAL].

- ③ Push and hold [LOW•PRIO] for 1 sec. to start the watch.
  - The transceiver checks the memory or call channel every 5 sec.
  - The watch resumes according to the selected scan resume condition. (p. 78)
- ④ Push and hold [LOW•PRIO] for 1 sec. to stop the watch.



- ① Select VFO mode; then, set the desired frequency.

- ② Set the watched channel(s).

**For memory channel watch:**

Push [MR/CALL] then [▲] or [▼] to select the desired memory channel.

**For memory scan watch:**

Push [MR/CALL], then push [SCAN 2] to start the memory scan.

**For call channel watch:**

Push [MR/CALL] for 1 sec. then push [▲] or [▼] to select the call channel.

- ③ Push [PRIO 3(PTT-M)] to start the watch.
  - The transceiver checks the memory or call channel every 5 sec.
  - The watch resumes according to the selected scan resume condition. (p. 78)
  - To resume the watch manually when paused, push [PRIO 3(PTT-M)].
- ④ To stop the watch, push [CLR A(MW)].

## ■ Programming a DTMF tone sequence

DTMF tone sequences are used for autopatching, controlling other equipment, etc. The transceiver has 16 DTMF memory channels (d0–d#) for storage of often-used DTMF tone sequences of up to 24 digits.

- ① Push and hold **[TONE•DTMF]** for 1 sec.
- ② Rotate **[DIAL]** to select the “DTMF MEMORY,” then push **[MAIN•BAND]**.
- ③ Rotate **[DIAL]** to select the desired memory channel, then push **[MAIN•BAND]**.
  - A total of 16 channels, “d0” to “d#” are available.
- ④ Rotate the **[DIAL]** to select the desired code.
- ⑤ Push **[>](M/CALL•MW)** (Left band's) to select the next digit.
  - Pushing **[<](V/MHz•SCAN)** (Left band's) moves the cursor back-ward.
- ⑥ Repeat the steps ④ and ⑤ to set the desired DTMF tone sequence, then push **[MAIN•BAND]**.
- ⑦ Push **[BACK](V/MHz•SCAN)** (Right band's) twice to exit from DTMF memory screen.

**[EXAMPLE]:** Programming “5428AB453” into DTMF memory channel “d4.”

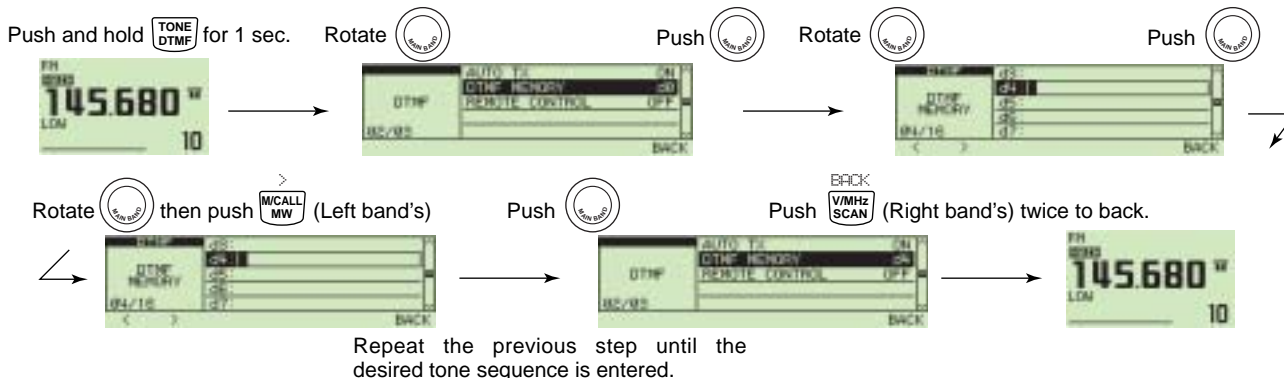

### ■ Transmitting a DTMF tone sequence

#### ◇ Automatic transmission (DTMF memory)

- ① Push and hold **[TONE•DTMF]** for 1 sec. to enter DTMF set mode.
- ② Rotate **[DIAL]** to select “DTMF MEMORY,” then push **[MAIN•BAND]** to enter DTMF memory screen.
- ③ Rotate **[DIAL]** to select the desired DTMF memory channel to be transmitted then push **[BACK](V/MHz•SCAN)** (Right band's).
  - Returns to DTMF set mode screen.
- ④ Rotate **[DIAL]** to select “AUTO TX,” then push **[MAIN•BAND]**.
- ⑤ Rotate **[DIAL]** to select “ON,” then push **[MAIN•BAND]**.
  - “☎” appears.
- ⑥ Push **[BACK](V/MHz•SCAN)** (Right band's) to exit from DTMF set mode.
- ⑦ Push **[PTT]** to transmit the selected DTMF memory content.
- ⑧ To cancel the DTMF tone sequence automatic transmission, select “OFF” in step ⑤.
  - When the DTMF encoder is turned ON continuously, each push of the PTT transmits the previously selected DTMF tone sequence.



- ① Push **[FUNC]** then **[Low 6(DTMF)]** to turn the DTMF memory encoder ON.
  - “☎” appears.
- ② Push **[PTT]** to transmit the previously selected DTMF memory.
- ③ Push **[FUNC]** then **[SET B(D-OFF)]** to cancel the DTMF memory encoder.
  - When the DTMF encoder is turned ON continuously, each push of the PTT transmits the previously selected DTMF tone sequence.

### ◇ Transmitting a DTMF memory directly



- 1 Push [FUNC] then [Low 6(DTMF)] to turn the DTMF memory encoder ON.
  - “☎” appears.
- 2 Push [DTMF-S] to turn the DTMF memory direct selection ON.
  - The function indicator (microphone) lights green.
- 3 Push the desired DTMF channel.
  - “0” to “9,” “A” to “D,” “\*” and “#” are available for DTMF memory channels.
  - The selected DTMF tone sequence is automatically transmitted without pushing PTT.

**NOTE:** When no DTMF tone sequence programmed channel number is pushed, it transmits the relative DTMF tone sequence as the manual transmission described as at right.
- 4 Push [DTMF-S] again to deactivate the DTMF memory direct selection.
- 5 Push [FUNC] then [SET B(D-OFF)] to cancel the DTMF memory encoder.

### ◇ Manual transmission



- 1 Deactivate the DTMF memory encoder by pushing [FUNC] then [SET B(D-OFF)].
- 2 Push [DTMF-S] to turn the DTMF direct selection ON.
  - The function indicator (microphone) lights green.
- 3 Push one of “0” to “9” and “A” to “F” keys momentarily, then push the desired DTMF keys, 0–9 and A to F.
 

• A: [CLR A(MW)]	B: [SET B(D-OFF)],
C: [ENT C(T-OFF)]	D: [SQL▲ D(MUTE)],
E: [* (TONE-1)]	F: [SQL▼ # (16KEY-L)]

  - Automatically transmits without pushing PTT.
  - The first code entering will not transmitted. DTMF code transmission starts from the 2nd code.
- 4 Push [DTMF-S] again to deactivate the DTMF direct selection.

---

## 10 DTMF MEMORY ENCODER

### ■ DTMF speed

The rate at which DTMF values in memory send individual DTMF characters can be set to accommodate operating needs.

- ① Push [**F**••••] to display the function guide.
- ② Push [**MENU**](V/MHz•SCAN) (Right band's) to enter MENU screen.
- ③ Rotate [**DIAL**] to select "DUP/TONE...", then push [**MAIN**•BAND].
- ④ Rotate [**DIAL**] to select "DTMF SPEED," then push [**MAIN**•BAND].
- ⑤ Rotate [**DIAL**] to select the desired speed as shown in the table below, then push [**MAIN**•BAND].
- ⑥ Push [**BACK**](V/MHz•SCAN) (Right band's) twice to return

DISPLAY	INTERVAL	SPEED
100	100 msec.	5.0 cps
200	200 msec.	2.5 cps
300	300 msec.	1.6 cps
500	500 msec.	1.0 cps

to frequency indication.  
cps=characters/sec

## ■ Tone/DTCS squelch beep operation

- ① Set the desired operating frequency and the desired operating mode.
- ② Set the desired CTCSS tone or DTCS code.
- ③ Push **[TONE•DTMF]** several times to select the desired squelch system
  - “T SQL” : Tone squelch with pocket beep; “DTCS” : DTCS squelch with pocket beep; “T SQL” : Tone squelch; “DTCS” : DTCS squelch
- ④ When a signal with the correct tone or code is received, the transceiver’s mute is released and received audio sounds.
  - Emits beep tones for 30 sec. and blinks “” if pocket beep is selected in step ③.
- ⑤ Push **[PTT]** to answer or push **[MAIN•BAND]** to stop the beeps and blinking.

Pocket beep



DTCS beep

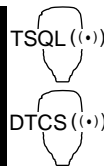
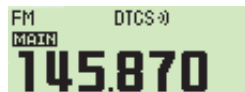

- ① Set the operating frequency.
- ② Push **[FUNC]** then push one of following keys to turn the desired squelch system ON.
  - **[HIGH 4(DTCS)]** : DTCS squelch
  - **[MID 5(DTCS ((•)))]** : DTCS squelch with pocket beep
  - **[DUP+ 8(TSQL ((•)))]** : Tone squelch with pocket beep
  - **[SIMP 9(TSQL)]** : Tone squelch
- ③ When a signal with the correct tone or code is received, the transceiver’s mute is released and received audio sound.
  - Emits beep tones for 30 sec. and blinks “” if pocket beep is selected in step ③.
- ④ Push **[PTT]** to answer or push **[CLR A(MW)]** to stop the beeps and blinking.
  - “” disappears and cancels the pocket beep function automatically.
- ⑤ To cancel the tone squelch or DTCS squelch function, push **[FUNC]** then **[ENT C(T-OFF)]**.
  - “TSQL” or “DTCS” disappears

### NOTE:

- The DTCS squelch operation on sub band does not function during DTCS transmission because the same encoder/decoder circuit is being used for both main and sub bands. Tone squelch operation on sub band may not be performed correctly during DTCS transmission.

- The tone/DTCS code squelch opens sometimes when other stations communicate using an adjacent tone frequency or in a DTCS code.
- The tone/DTCS code squelch can be operated on FM or FM-N mode only.

# 11 TONE SQUELCH AND POCKET BEEP

## ◇ Reverse tone/DTCS squelch

The reverse tone/DTCS squelch is convenient if you want to ignore a specific signal.

- ① Set the desired operating frequency and the desired operating mode.
- ② Push **[TONE•DTMF]** several times to select “T SQL-R” or “DTCS-R” appears.

Tone squelch reverse

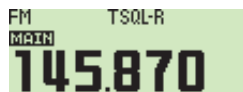

DTCS reverse



- ③ When a signal with unmatched tone or code is received, the transceiver's mute is released and the received audio sounds.  
The transceiver mutes the squelch when a signal with the matched tone or code is received.

## ◇ Setting tone squelch frequency

- ① Push **[F•T•O]** to display the function guide.
- ② Push **[MENU](V/MHz•SCAN)** (Right band's) to enter MENU screen.
- ③ Rotate **[DIAL]** to select “DUP/TONE...” then push **[MAIN•BAND]**.
- ④ Rotate **[DIAL]** to select “CTCSS TONE” then push **[MAIN•BAND]**.
- ⑤ Rotate **[DIAL]** to select the desired CTCSS tone frequency then push **[MAIN•BAND]**.
  - Each operating band and each memory channel have independent settings.
  - See the table on page 88 for available tone frequencies.

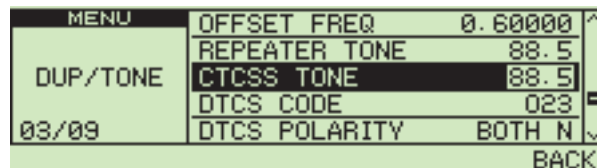

- ⑥ Push **[BACK](V/MHz•SCAN)** (Right band's) to exit from DUP/TONE set mode.



- ① Push **[SET B(D-OFF)]** to enter set mode.
- ② Push **[▲]/[▼]** several times to select “DUP/TONE...” then push **[SET B(D-OFF)]**.
- ③ Push **[▲]/[▼]** several times to select “CTCSS TONE” then push **[SET B(D-OFF)]**.
- ④ Push **[▲]/[▼]** to select the desired tone frequency then push **[SET B(D-OFF)]**.
- ⑤ Push **[CLR A(MW)]** to exit DUP/TONE set mode.

◇ **Setting DTCS code**

- ① Push **[F••••]** to display the function guide.
- ② Push **[MENU](V/MHz•SCAN)** (Right band's) to enter MENU screen.
- ③ Rotate **[DIAL]** to select "DUP/TONE..." then push **[MAIN•BAND]**.
- ④ Rotate **[DIAL]** to select "DTCS CODE" then push **[MAIN•BAND]**.
- ⑤ Rotate **[DIAL]** to select the desired DTCS code then push **[MAIN•BAND]**.
  - Each operating band and each memory channel have independent settings.
  - See the table at right for available DTCS code.

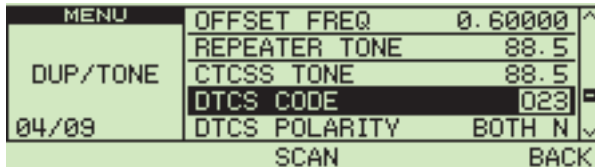

- ⑥ Push **[BACK](V/MHz•SCAN)** (Right band's) to exit from DUP/TONE set mode.

/// DTCS mode can be selected in "DTCS POLARITY" menu. (p. 89)



- ① Push **[SET B(D-OFF)]** to enter set mode.
- ② Push **[▲]/[▼]** several times to select "DUP/TONE..." then push **[SET B(D-OFF)]**.
- ③ Push **[▲]/[▼]** several times to select "DTCS CODE" then push **[SET B(D-OFF)]**.
- ④ Push **[▲]/[▼]** to select the desired DTCS code then push **[SET B(D-OFF)]**.
- ⑤ Push **[CLR A(MW)]** to exit DUP/TONE set mode.

• **Available tone frequency**

67.0	79.7	94.8	110.9	131.8	156.7	171.3	186.2	203.5	229.1
69.3	82.5	97.4	114.8	136.5	159.8	173.8	189.9	206.5	233.6
71.9	85.4	100.0	118.8	141.3	162.2	177.3	192.8	210.7	241.8
74.4	88.5	103.5	123.0	146.2	165.5	179.9	196.6	218.1	250.3
77.0	91.5	107.2	127.3	151.4	167.9	183.5	199.5	225.7	254.1

• **Available DTCS code**

023	054	125	165	245	274	356	445	506	627	732
025	065	131	172	246	306	364	446	516	631	734
026	071	132	174	251	311	365	452	523	632	743
031	072	134	205	252	315	371	454	526	654	754
032	073	143	212	255	325	411	455	532	662	
036	074	145	223	261	331	412	462	546	664	
043	114	152	225	263	332	413	464	565	703	
047	115	155	226	265	343	423	465	606	712	
051	116	156	243	266	346	431	466	612	723	
053	122	162	244	271	351	432	503	624	731	

## ■ DTCS polarity setting

- ① Push [**F**•**→**] to display the function guide.
- ② Push [**MENU**](V/MHz•**SCAN**) (Right band's) to enter MENU screen.
- ③ Rotate [**DIAL**] to select "DUP/TONE..." then push [**MAIN**•**BAND**].
- ④ Rotate [**DIAL**] to select "DTCS POLARITY" then push [**MAIN**•**BAND**].
- ⑤ Rotate [**DIAL**] to select the desired DTCS polarity then push [**MAIN**•**BAND**].
  - **BOTH N** : Normal phase is used for both TX and RX. (Default)
  - **TN-RR** : Normal phase is used for TX; Reverse phase for RX.
  - **TR-RN** : Reverse phase is used for TX; Normal phase for RX.
  - **BOTH R** : Reverse phase is used for both TX and RX.

MENU	OFFSET FREQ	0.60000	^
	REPEATER TONE	88.5	
DUP/TONE	CTCSS TONE	88.5	
	DTCS CODE	023	▣
05/09	DTCS POLARITY	BOTH N	∨
			BACK

- ⑥ Push [**BACK**](V/MHz•**SCAN**) (Right band's) to exit from DUP/TONE set mode.



- ① Push [SET B(D-OFF)] to enter set mode.
- ② Push [▲]/[▼] several times to select "DUP/TONE..." then push [SET B(D-OFF)].
- ③ Push [▲]/[▼] several times to select "DTCS POLARITY" then push [SET B(D-OFF)].
- ④ Push [▲]/[▼] to select the desired polarity then push [SET B(D-OFF)].
- ⑤ Push [CLR A(MW)] to exit DUP/TONE set mode.

## ■ Tone scan

By monitoring a signal that is being operated with pocket beep, tone or DTCS squelch function, you can determine the tone frequency or DTCS code necessary to open squelch.

- ① Push **[F•T•O]** to display the function guide.
- ② Push **[MENU](V/MHz•SCAN)** (Right band's) to enter MENU screen.
- ③ Rotate **[DIAL]** to select "DUP/TONE..." then push **[MAIN•BAND]**.
- ④ Rotate **[DIAL]** to select either "REPEATER TONE," "CTCSS TONE" or "DTCS CODE" to be scanned.
- ⑤ Push **[SCAN](TONE•DTMF)** to start tone scan.
  - To change the scanning direction, rotate **[DIAL]**.

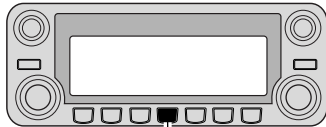

During Repeater tone scan



During CTCSS frequency scan



During DTCS code scan

- ⑥ When the CTCSS tone frequency or 3-digit DTCS code is matched, the squelch opens and the tone frequency is temporarily programmed into the selected feature, such as memory or call channel.
  - The tone scan pauses when a CTCSS tone frequency or 3-digit DTCS code is detected.
  - The decoded CTCSS tone frequency or 3-digit DTCS code is used for the tone encoder or tone encoder/decoder, depending on the selected tone condition or type in step ④.
    - "REPEATER TONE" : Tone encoder for repeater operation
    - "CTCSS TONE" : CTCSS tone encoder/decoder
    - "DTCS" : DTCS tone encoder/decoder
- ⑦ Push **[V/MHz•SCAN]** to stop the scan.



- ① Set the frequency or memory channel to be checked for a tone frequency.
- ② Selects the tone type to be scanned.
  - Push **[FUNC]** then push; **[SIMP 9(TSQL)]** for tone squelch; **[HIGH 4(DTCS)]** for DTCS squelch.
- ③ Push **[FUNC]** then **[SCAN 2(T-SCAN)]** to start the tone scan.
- ④ When the tone frequency is matched, the squelch opens and the tone frequency is programmed into the selected mode, such as memory or call channel.
- ⑤ Push **[CLR A(MW)]** to stop the scan.

**NOTE:** The decoded tone frequency is programmed temporarily when a memory or call channel is selected. However, this will be cleared when the memory/call channel is re-selected.

# 11 TONE SQUELCH AND POCKET BEEP

## ■ Digital call sign/digital code squelch

*The optional UT-123*

**NOTE:** Use digital code squelch when operating with two or more stations. Because the digital call sign squelch function recognizes “**MY CALL SIGN**,” the digital call sign squelch function can be used when operating with only one station.

- ① Set the desired operating frequency in DV mode, Digital code and MY CALL SIGN.
- ② Push **[TONE•DTMF]** several times to activate the digital code or digital call sign squelch. (DSQL or CSQL)
  - Digital call sign squelch “DSQL,” Digital call sign beep “DSQL:~)”
  - Digital code squelch “CSQL,” Digital code beep “CSQL:~)” and no tone operation are activated in order.
- ③ Operate the transceiver in the normal way.
- ④ When the received signal includes a matching call sign/code, the squelch opens and the signal can be heard.
  - When the received signal’s call sign/code does not match, digital call sign/digital code squelch does not open; however, the S/R/F indicator shows signal strength.

Digital call sign pocket beep



Digital code pocket beep



Digital call sign squelch

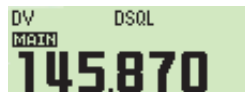

Digital code squelch



### ◇ YOUR and MY call signs setting

See page 39 for DV MODE OPERATION.

### ◇ Digital code setting

- ① Push **[F•--->]** to display the function guide, then push **[MODE](V/MHz•SCAN)** (Left band's) several times to select DV mode.
- ② Push **[MENU](V/MHz•SCAN)** (Right band's) to enter MENU screen.
- ③ Rotate **[DIAL]** to select “DV SET MODE” then push **[MAIN•BAND]**.
- ④ Rotate **[DIAL]** to select “DIGITAL CODE” then push **[MAIN•BAND]**.
- ⑤ Rotate **[DIAL]** to select the desired digital code (00–99) then push **[MAIN•BAND]**.
  - Each operating band and each memory channel have independent settings.

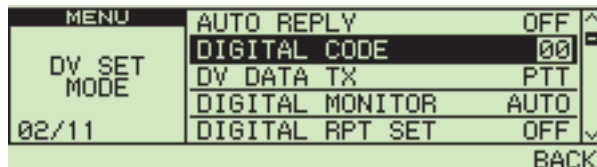

- ⑥ Push **[BACK](V/MHz•SCAN)** (Right band's) twice to return to frequency indication.

## ■ Pager function

This function uses DTMF codes for paging and can be used as a “message pager” to confirm you of a caller’s identification even when you leave the transceiver temporarily unattended.

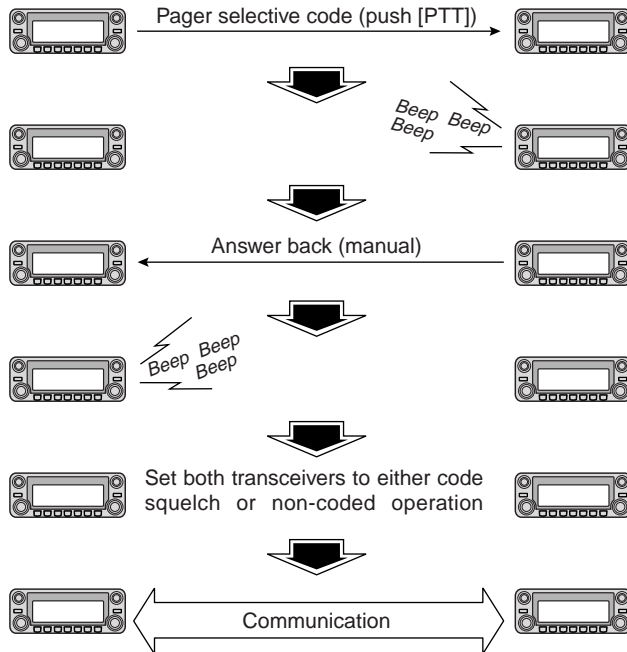

## ■ Code programming

### ◇ Before programming

The pager and code squelch functions require ID codes and a group code. These codes are 3-digit DTMF codes and must be written into the code channels before operation.

- ① Decide the ID code of each transceiver and a group code for your group.
- ② Decide whether you want to return to normal operation or code squelch operation after a connection is made.
- ③ Program the ID code, group code and transmit codes (other station’s codes) as below.

### ◇ Code channel assignment

ID OR GROUP CODE	CODE CHANNEL NUMBER	“RECEIVE ACCEPT” OR “RECEIVE INHIBIT”
Your ID code	C0	“Receive accept” only
Other parties’ ID code	C1–C5	“Receive inhibit” should be programmed in each channel.
Group code	One of C1–C5	“Receive accept” must be programmed in one channel.
Memory space*	P	“Receive inhibit” only.

\*Channel CP automatically memorizes an ID code when receiving a pager call. The contents in channel CP cannot be changed manually.

## 12 PAGER/CODE SQUELCH

### ◆ Code programming

Your ID code **MUST** be programmed into code channel C0. Up to 5 transmit codes (codes that you transmit) are programmable into code channels, C1 to C5, if required.

- ① Push **[F•→•0]** to display the function guide.
- ② Push **[MENU](V/MHz•SCAN)** (Right band's) to enter MENU screen.
- ③ Rotate **[DIAL]** to select "DUP/TONE..." then push **[MAIN•BAND]**.
- ④ Rotate **[DIAL]** to select "PGR MEMORY", then push the **[MAIN•BAND]**.
- ⑤ Rotate **[DIAL]** to select code channel C0.
  - "C0" is your ID code and "C1" to "C5" are transmit codes.
  - Each transceiver should have a different ID code.
- ⑥ Push **[MAIN•BAND]** to select the pager code programming condition.
- ⑦ Rotate **[DIAL]** to select number (0–9) and push **[>](M/CALL•MW)** (Left band's) or **[<](V/MHz•SCAN)** (Left band's) to select the digit.
- ⑧ Repeat the step ⑦ to enter the desired 3-digit ID code, then push **[MAIN•BAND]**.
- ⑨ Rotate **[DIAL]** to select a transmit code channel from C1 to C5, then push the **[MAIN•BAND]**.
- ⑩ Enter the desired 3-digit transmit code as described in steps ⑦ and ⑧.
- ⑪ Push **[SKIP](V/MHz•SCAN)** (Left band's) to set the channel to "receive inhibit" or "receive accept" ON and OFF.
  - When "receive inhibit" is set, "SKIP" appears.
  - Code channel C0 cannot be set as "receive inhibit."
  - See the table for "receive accept" and "receive inhibit" details on the previous page.
- ⑫ Repeat steps ⑨ and ⑪ to set additional transmit code channels, if desired.
- ⑬ Push **[BACK](V/MHz•SCAN)** (Right band's) twice to return to frequency indication.

#### • Receive accept/receive inhibit

- "Receive accept" (no "SKIP" indication) accepts pager calls when the transceiver receives a signal with a code the same as that in the code channel.
- "Receive inhibit" ("SKIP" appears) ignores calls even when the transceiver receives a code that is the same as the code in the code channel. Transmit codes should therefore be programmed for "receive inhibit," otherwise the transceiver will not reject unnecessary calls.

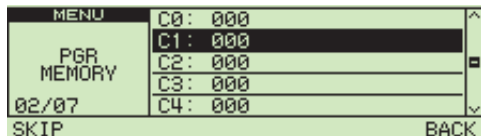

## ■ Pager operation

### ◇ Calling a specific station

- ① Program the pager code channel in advance (p. 93).
- ② Set the operating frequency.
  - Set the volume and squelch to the desired level as in normal operation.
- ③ Push **[F•---○]** to display the function guide.
- ④ Push **[MENU](V/MHz•SCAN)** (Right band's) to enter the MENU screen.
- ⑤ Rotate **[DIAL]** to select "DUP/TONE..." then push **[MAIN•BAND]** to enter DUP/TONE set mode.
- ⑥ Rotate **[DIAL]** to select the "PGR/C-SQL" then push **[MAIN•BAND]**.
- ⑦ Rotate **[DIAL]** to set "PGR" then push **[MAIN•BAND]**.

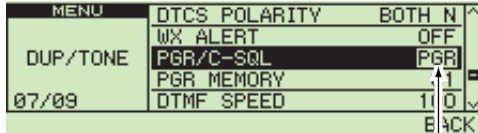

Select "PGR"

- ⑧ Select the desired 3-digit transmit code channel:
  - ➔ Rotate **[DIAL]** to select "PGR MEMORY" then push **[MAIN•BAND]**.
  - ➔ Rotate **[DIAL]** to select the desired pager code channel.
  - ➔ Push **[BACK](V/MHz•SCAN)** (Right band's) three times to return to frequency indication.
  - "PGR" appears in normal frequency indication.

- ⑨ Push **[PTT]** to transmit the pager code.
- ⑩ Wait for an answer back.
  - When the transceiver receives an answer back code, the function display shows the other member's ID or group code.
- ⑪ After confirming a connection, perform the previous steps ③ to ⑦ and select the code squelch operation "C-SQL," or non-selective calling system, "OFF" in step ⑦.
  - Push **[BACK](V/MHz•SCAN)** (Right band's) twice to return to frequency indication.
- ⑫ Communicate with the other party as normal: push **[PTT]** to transmit; release to receive.

### ◇ Waiting for a call from a specific station

- ① Set the operating frequency.
- ② Turn pager function ON.
  - Perform the steps ③ to ⑦ in "◇ Calling a specific station" as at left.
  - "PGR" indication appear.
- ③ Wait for a call.
  - When receiving a call, the caller's ID or group code appears as shown at next page.
- ④ Push **[PTT]** to send an answer-back call and display the operating frequency.
- ⑤ After confirming a connection, select the code squelch operation "C-SQL," or non-selective calling system "OFF."

## 12 PAGER/CODE SQUELCH

### • PERSONAL CALLS

This display appears when you are called with your ID code and the calling station's ID code is 444.



### • GROUP CALLS

This display appears when you are called with the group code (444), provided 444 has been programmed into code channel C3.

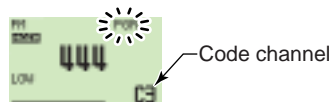

### • ERROR INFORMATION

When the transceiver receives an incomplete code, “E” and previously received code appear.

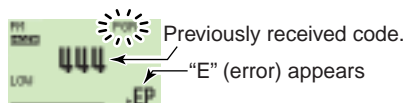

## ■ Code squelch

When using code squelch you will only receive calls from stations which know your ID or group code. A 3-digit code is sent each time **[PTT]** is pushed in order to open the receiving station's code squelch prior to voice transmission.

- ① Set the operating frequency.
  - Set the volume and squelch to the desired level as in normal operation.
- ② Push **[F•T•O]** to display the function guide.
- ③ Push **[MENU](V/MHz•SCAN)** (Right band's) to enter the MENU screen.
- ④ Rotate **[DIAL]** to select “DUP/TONE...” then push **[MAIN•BAND]** to enter DUP/TONE set mode.
- ⑤ Rotate **[DIAL]** to select the “PGR/C-SQL” then push **[MAIN•BAND]**.
- ⑥ Rotate **[DIAL]** to set “C-SQL” then push **[MAIN•BAND]**.
- ⑦ Rotate **[DIAL]** to select “PGR MEMORY” then push **[MAIN•BAND]**.
- ⑧ Rotate **[DIAL]** to select the desired transmit code channel:
  - ➔ Rotate **[DIAL]** to select the desired code channel.
  - ➔ Push **[BACK](V/MHz•SCAN)** (Right band's) three times to return to frequency indication.
    - “C-SQL.” appears.
- ⑨ Operate the transceiver in the normal way (push **[PTT]** to transmit; release **[PTT]** to receive).
- ⑩ To cancel the code squelch, enter “PGR/C-SQL” set item, then rotate **[DIAL]** to select “OFF”
  - “C-SQL” disappears.

# EXTERNAL DTMF REMOTE 13

External DTMF remote function can be remotely controlled using DTMF signals on the sub band. To operate external DTMF remote, a 144MHz or 430(440) MHz transceiver with a DTMF encoder is required.

- ① Set the sub band frequency to receive a control signal (DTMF code).
  - The tone squelch function can be used for the sub band to increase remote control reliability. (p. 86)
- ② Program a 3-digit password into the sub band's code channel 5 ("PGR MEMORY"), if desired. (p. 94)
  - The initial value of code channel 5 is "000 (default); receive accept." If you do not require the password, set the channel as "receive inhibit."
- ③ Select the main band by pushing the desired band's (Left or Right) **[MAIN•BAND]**, then set the desired frequency for operation.
- ④ Push and hold **[TONE•DTMF]** for 1 sec. to enter DTMF set mode, then rotate **[DIAL]** to select "REMOTE CONTROL."
- ⑤ Push **[MAIN•BAND]**, then rotate **[DIAL]** to select ON.
- ⑥ Push **[BACK](V/MHz•SCAN)** (Right band's) twice to return to frequency indication.
  - "R" indicator appears
- ⑦ Set the operating frequency of the controller transceiver equal to the sub band frequency of the IC-2820H.
  - Make sure a tone frequency is set when using the tone squelch function with the IC-2820H.
  - The external DTMF remote does not accept a control signal on the main band frequency.

- ⑧ From the controller transceiver, transmit the DTMF code as follows:

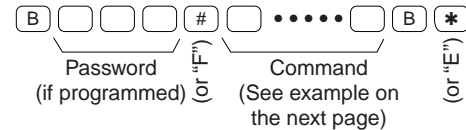

- ⑨ To cancel standby for the remote control, select "OFF" in "REMOTE CONTROL" item in DTMF set mode.
  - "R" disappears.



## ■ General

MENU screen is used for programming infrequently changed values or conditions of functions.

### • Entering MENU screen and operation

- ① Push [**F**•**→**•**○**] to display the function guide.
- ② Push [**MENU**](V/MHz•SCAN) (Right band's) to enter MENU screen.

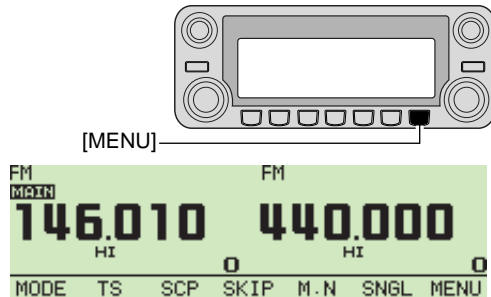

- ③ Rotate [**DIAL**] to select the desired menu group, then push [**MAIN**•**BAND**].
- ④ Rotate [**DIAL**] to select the desired item, then push [**MAIN**•**BAND**].
- ⑤ Rotate [**DIAL**] to select the desired condition or value, then push [**MAIN**•**BAND**].
- ⑥ Push [**F**•**→**•**○**] to return to frequency indication or push [**BACK**](V/MHz•SCAN) (Right band's) to return the previous screen.



- ① Push [SET B(D-OFF)] to enter MENU screen.
- ② Push [▲] or [▼] to select the desired menu group, then push [SET B(D-OFF)] to enter the appropriate set mode.
- ③ Push [▲] or [▼] to select the desired item, then push [SET B(D-OFF)].
- ④ Push [▲] or [▼] to select the condition or value then push [SET B(D-OFF)].
- ⑤ Push [CLR A(MW)] to exit set mode or push [ENT C(T-OFF)] to return to the previous indication.

## ■ Menu list

ITEMS	REF.	ITEMS	REF.
CALL SIGN MEMORY†	—	DUP/TONE...	p. 106
RX CALL SIGN†	—	DISPLAY	p. 107
DV MESSAGE†	—	SOUNDS	p. 109
DV VOICE MEMO†	—	DV GPS	p. 110
SET MODE	p. 101	PACKET	p. 111
DV SET MODE	p. 103	GPS SET MODE	p. 111
SCAN	p. 105	GPS-A SET MODE	p. 113

†Refer to the chapter 5 for details.

# 14 MENU SCREEN OPERATION

## ■ Items list

### ◇ CALL SIGN MEMORY†

ITEMS	REF.	ITEMS	REF.
YOUR CALL SIGN MEMORY	—	MY CALL SIGN MEMORY	—
RPT CALL SIGN MEMORY	—		—

### ◇ RX CALL SIGN†

ITEMS	REF.	ITEMS	REF.
RX01: /	—	⋮	—
RX02: /	—	RX19: /	—
⋮	—	RX20: /	—

### ◇ DV MESSAGE†

ITEMS	REF.	ITEMS	REF.
TX MESSAGE MEMORY	—	RX MESSAGE	—

### ◇ DV VOICE MEMO†

ITEMS	REF.	ITEMS	REF.
REPLY VOICE	—	TRACK SIZE	—

†Refer to the chapter 5 for details.

### ◇ SET MODE

ITEMS	REF.	ITEMS	REF.
TIME-OUT TIMER	p. 101	MIC SENS LEVEL	p. 102
AUTO POWER OFF	p. 101	AUTO ATT	p. 102
PTT LOCK	p. 101	ALC	p. 102
BUSY LOCKOUT	p. 101	DIVERSITY	p. 102
AUTO REPEATER	p. 101	GPS	p. 102
FAN CONTROL	p. 101	HM-154 UP	p. 102
SQL DELAY	p. 102	HM-154 DN	p. 102

### ◇ DV SET MODE

ITEMS	REF.	ITEMS	REF.
AUTO REPLY	p. 103	RXRPT WRITE	p. 104
DIGITAL CODE	p. 103	DV AUTO DETECT	p. 104
DV DATA TX	p. 103	EDIT RECORD	p. 104
DIGITAL MONITOR	p. 103	EMR	p. 104
DIGITAL RPT SET	p. 103	BK	p. 104
RXCALL WRITE	p. 103		

### ◇ SCAN

ITEMS	REF.	ITEMS	REF.
SCAN TIMER	p. 105	BANK LINK SCAN	p. 105
PROGRAM SKIP SCAN	p. 105	BANK LINK	p. 105

◇ DUP/TONE...

ITEMS	REF.	ITEMS	REF.
OFFSET FREQ	p. 106	WX ALERT	p. 106
REPEATER TONE	p. 106	PGR/C-SQL	p. 107
CTCSS TONE	p. 106	PGR MEMORY	p. 107
DTCS CODE	p. 106	DTMF SPEED	p. 107
DTCS POLARITY	p. 106		

◇ DISPLAY

ITEMS	REF.	ITEMS	REF.
BACKLIGHT	p. 107	OPENING CALL S	p. 108
DIMMER	p. 107	SCAN NAME	p. 108
AUTO DIMMER	p. 107	RX CALL SIGN	p. 108
LCD CONTRAST	p. 107	TX CALL SIGN	p. 108
OPENING LOGO	p. 108	RX MESSAGE	p. 108

◇ SOUNDS

ITEMS	REF.	ITEMS	REF.
KEY-TOUCH BEEP	p. 109	SUB BAND MUTE	p. 109
BEEP LEVEL	p. 109	SUB BAND BEEP	p. 109
SCOPE AF OUTPUT	p. 109	STANDBY BEEP	p. 109

◇ DV GPS

ITEMS	REF.	ITEMS	REF.
GPS SENTENCE	p. 110	GPS TX	p. 110
GPS MESSAGE	p. 110	GPS AUTO TX	p. 110
RX GPS MESSAGE	p. 110		

◇ PACKET

ITEMS	REF.	ITEMS	REF.
PACKET BPS	p. 111	PACKET BAND	p. 111

◇ GPS SET MODE

ITEMS	REF.	ITEMS	REF.
GPS SPEED	p. 111	GPS DATUM	p. 111
UNITS	p. 111	ALM AREA1	p. 112
COMPASS	p. 111	ALM AREA2	p. 112
UTC OFFSET	p. 111		

◇ GPS-A SET MODE

ITEMS	REF.	ITEMS	REF.
UNPROTO ADDRESS	p. 113	GPS-A SYMBOL	p. 113
DATA EXTENSION	p. 113	COMMENT	p. 114
TIME STAMP	p. 113		

## 14 MENU SCREEN OPERATION

### ■ SET MODE items

#### ◇ Time-out timer

To prevent accidental prolonged transmission, etc., the transceiver has a time-out timer. This function cuts a transmission OFF after 3, 5, 15 or 30 min. of continuous transmission. This timer can be cancelled.

- OFF : The time-out timer is turned OFF. (default)
- 3, 5, 15, 30 MIN : The transmission is cut OFF after the set period elapses.

#### ◇ Auto power OFF

The transceiver can be set to automatically turn OFF after a specified period with a beep when no key operations are performed.

30 min, 60 min, 90 min, 120 min and OFF (default) can be specified. The specified period is retained even when the transceiver is turned OFF by the auto power OFF function. To cancel the function, select "OFF" in this set mode.

#### ◇ PTT lock

Turns the PTT lock function ON and OFF (default).

Transmission with **[PTT]** is inhibited when ON is selected to prevent accidental transmission, etc.

#### ◇ Busy lockout

Turns the busy lockout function ON and OFF (default).

This function inhibits transmission while receiving a signal or when the squelch is open

#### ◇ Auto repeater

USA/KOREAN versions only

The auto repeater function automatically turns ON or OFF duplex operation and the tone encoder. The offset and repeater tone is not changed by the auto repeater function. Reset these frequencies, if necessary.

#### USA version:

- OFF : The auto repeater function is turned OFF.
- RPT1 : Activates for duplex only. (default)
- RPT2 : Activates for duplex and tone.

#### Korean version:

- OFF : Deactivates the function.
- ON : Activates duplex and tone. (default)

#### ◇ Fan control

Selects the cooling fan control condition from AUTO, FAST, MID and SLOW.

- AUTO : The fan rotates during transmit and for 2 min. after transmission. (default)
- FAST : The fan continuously rotates at fast speed.
- MID : The fan continuously rotates at medium speed.
- SLOW : The fan continuously rotates at low speed.

### ◇ Squelch delay

Selects squelch delay from short and long to prevent repeated opening and closing of the squelch during reception of the same signal.

- SHORT : Short squelch delay. (default)
- LONG : Long squelch delay

### ◇ Mic sens level

Selects the microphone sensitivity from HIGH and LOW to suit your preference. (default : USA version; LOW, Other versions; HIGH)

### ◇ Auto ATT

The attenuator prevents distortion of a desired signal by very strong RF signals near the desired frequency or when very strong electric fields, such as from a broadcasting station, are present at your location.

Select the attenuator function ON (default) and OFF.

### ◇ ALC

Sets the ALC (Automatic Level Control) function ON and OFF (default).

The ALC function reduces the microphone again automatically when the transmission audio is distorted.

### ◇ Diversity

Turns the diversity function ON and OFF (default).

### ◇ GPS

Turns the GPS function ON (default) and OFF.

### ◇ HM-154 UP/DN

Sets the assigning function to the [UP]/[DN] keys on the optional HM-154.

#### Assignable functions:

- MIC-UP\* (default)
- MIC-DN† (default)
- F/LOCK (as [F•LOCK])
- DUP/MONI (as [DUP•MONI])
- TONE/DTMF (as [TONE•DTMF])
- LOW/PRIO (as [LOW•PRIO])
- L M.CALL/MW (as [M/CALL•MW] for Left band)
- L V/MHz/SCAN (as [V/MHz•SCAN] for Left band)
- L MAIN/BAND (as [MAIN•BAND] for Left band)
- R M.CALL/MW (as [M/CALL•MW] for Right band)
- R V.MHz/SCAN (as [V/MHz•SCAN] for Right band)
- R MAIN/BAND (as [MAIN•BAND] for Right band)

\*Available for “HM-154 UP” only; †Available for “HM-154 DN” only

---

## 14 MENU SCREEN OPERATION

### ■ DV SET MODE items

The following items are selectable by optional UT-123 is installed into the IC-2820H.

#### ◇ Auto reply

This function replies to an individual station call even you are away from the transceiver.

After a manual transmission (pushing **[PTT]**), the Auto Reply setting returns to OFF automatically.

- OFF : No reply is performed even a call is received.  
(default)
- ON : Sets caller's call sign and reply to the call with the set own call sign automatically.
- VOICE : Reply to the call with the recorded voice memory.

#### ◇ Digital code

Sets the desired digital code for digital code squelch operation. A total of 100 codes (00–99) are available. (default: 00)

#### ◇ DV data TX

During low-speed data operation, auto data transmission function is available. This function transmits when data has been input from PC via the **[DATA]** jack. (default: PTT)

#### ◇ Digital monitor

Sets the desired monitoring mode during DV mode operation from "AUTO," "DIGITAL" and "ANALOG."

- AUTO : The transceiver sets monitoring mode to FM and DV according to the received signal.  
(default)
- DIGITAL : Monitors in DV mode.
- ANALOG : Monitors in FM mode.

#### ◇ Digital repeater setting

When accessing a digital repeater with a call sign different than is programmed, the repeater call sign can be stored into "RPT1" and/or "RPT2" automatically by reading the repeater's transmission. The stored repeater's call sign can be re-called when selecting the repeater call sign. (default: OFF)

#### ◇ RX call sign auto write

When an individual station call is received, the calling station call sign can be automatically set in "YOUR." (default: OFF)

### ◇ Repeater call sign auto write

When accessing a repeater with a call sign that is different than the one programmed in your radio, the repeater call sign can be set into “RPT1” and or “RPT2” automatically by reading the repeater’s transmission. (default: OFF)

/// The transceiver sets the received repeater call sign for operation. Therefore, when a different call sign is set for operation, the previously set repeater call sign will be lost.

### ◇ DV auto detect

When a signal other than DV mode is received during DV mode operation, the transceiver has the capability of automatic FM mode selection.

- OFF : Operating mode is fixed in DV. (default)
- ON : The transceiver automatically selects FM mode for temporary operation.

### ◇ Call sign edit record

Selects the call sign programming when the call sign is edited or corrected with the pre-programmed call sign via call sign set screen.

- SELECT : The edited or corrected call sign is programmed (over written) into the selected call sign memory.
- AUTO : The edited or corrected call sign is programmed into a blank channel automatically. (default)

### ◇ EMR communication

Turns the EMR communication mode ON and OFF (default).

### ◇ Break-in communication

Turns the break-in communication mode ON and OFF (default).

## 14 MENU SCREEN OPERATION

### ■ SCAN items

#### ◇ Scan timer

Selects scan resume timer from T-15 (default), T-10, T-5 and P-2.

- T-15/10/5 : Scan pauses for 15/10/5 sec., then resumes.
- P-2 : Pause on a signal until signal disappears, then resumes 2 sec. after the signal disappears.

#### ◇ Program skip scan

Sets programmed skip scan setting from ON (default) and OFF for full scan or programmed scan operation.

#### ◇ Bank link scan

Sets the memory bank link function ON and OFF (default). The link function provides continuous bank scan, scanning all contents in the selected banks during bank scan.

##### • Bank link setting

- ① Enter MENU screen via function guide.
  - ➔ Push **[F•T•O]** to display function guide.
  - ➔ Push **[MENU](V/MHz•SCAN)** (Right band's) to enter MENU screen.
- ② Rotate **[DIAL]** to select "SCAN," then push **[MAIN•BAND]**.
- ③ Rotate **[DIAL]** to select "BANK LINK," then push **[MAIN•BAND]** to enter bank setting.
- ④ Rotate **[DIAL]** to select the desired bank initial, then push **[MAIN•BAND]**.
- ⑤ Rotate **[DIAL]** to turn ON (default) and OFF the link setting, then push **[MAIN•BAND]**.
- ⑥ Rotate **[DIAL]** to select next bank and repeat steps ④ to ⑤, or push **[BACK](V/MHz•SCAN)** (Right band's) three times to exit scan set mode.

## ■ DUP/ TONE items

### ◇ Offset frequency

Sets the duplex offset frequency from 0 to 159.995 MHz. During duplex (repeater) operation, transmit frequency shifts the set frequency. (default value may differ depending on operating frequency band and versions)

- Push **[MHz](V/MHz•SCAN)** (Left band's) to tune in 1 MHz steps.

### ◇ Repeater tone

Sets subaudible tone frequency (encoder only) for repeater operation. Total of 50 tone frequencies (67.0–254.1 Hz) are available. (default: 88.5 Hz)

### ◇ CTCSS tone

Sets subaudible tone frequency (both encoder and decoder) for tone squelch operation. Total of 50 tone frequencies (67.0–254.1 Hz) are available. (default: 88.5 Hz)

#### • Available subaudible tone frequencies

67.0	79.7	94.8	110.9	131.8	156.7	171.3	186.2	203.5	229.1
69.3	82.5	97.4	114.8	136.5	159.8	173.8	189.9	206.5	233.6
71.9	85.4	100.0	118.8	141.3	162.2	177.3	192.8	210.7	241.8
74.4	88.5	103.5	123.0	146.2	165.5	179.9	196.6	218.1	250.3
77.0	91.5	107.2	127.3	151.4	167.9	183.5	199.5	225.7	254.1

### ◇ DTCS code

Sets DTCS code (both encoder and decoder) for DTCS squelch operation. Total of 104 codes are available. (default: 023)

#### • Available DTCS codes

023	054	125	165	245	274	356	445	506	627	732
025	065	131	172	246	306	364	446	516	631	734
026	071	132	174	251	311	365	452	523	632	743
031	072	134	205	252	315	371	454	526	654	754
032	073	143	212	255	325	411	455	532	662	
036	074	145	223	261	331	412	462	546	664	
043	114	152	225	263	332	413	464	565	703	
047	115	155	226	265	343	423	465	606	712	
051	116	156	243	266	346	431	466	612	723	
053	122	162	244	271	351	432	503	624	731	

### ◇ DTCS polarity

Sets DTCS polarities for transmission and reception from "BOTH N," "TN-RR," "TR-RN" and "BOTH R" (default: BOTH N)

### ◇ Weather alert function

USA version only

Turns weather alert function ON and OFF (default). See p. 123 for details.

---

## 14 MENU SCREEN OPERATION

### ◇ PGR/C-SQL

Sets pager or code squelch function ON (“PGR” for pager function ON; “C-SQL” for code squelch function ON) and OFF. (default: OFF)

### ◇ PGR MEMORY

Sets code memory for pager and code squelch operation. (default: C0)

See page 93 for code programming details.

### ◇ DTMF speed

The rate at which DTMF memories send individual DTMF characters can be set to accommodate operating needs.

- 100 : 100 msec. interval; 5.0 cps speed (default)
- 200 : 200 msec. interval; 2.5 cps speed
- 300 : 300 msec. interval; 1.6 cps speed
- 500 : 500 msec. interval; 1.0 cps speed

## ■ DISPLAY items

### ◇ Backlight

Sets backlighting color conditions. The color can be changed between red and green in 20 steps.

Red (Left edge) ↔ Yellow green (Center) ↔ Green (Right edge)  
(default: Center)

### ◇ Display dimmer

Sets backlighting brightness.

The levels 1 (dark) to 8 (bright: default) are available.

### ◇ Auto dimmer

Sets backlighting brightness when no operation is performed for approx. 5 sec.

- OFF : The backlight brightness will not be changed. (default)
- AUTO-OFF : The backlight will be turned OFF when no operation is performed for approx. 5 sec.
- AUTO-D1 to D7 : Brightness level 1 to 7 is selected when no operation is performed for approx. 5 sec.

### ◇ LCD contrast

The contrast of the LCD can be selected from 16 levels.

- 1 (Low contrast) to 16 (High contrast) (default: 6)

### ◇ Opening logo

The opening logo indication (Icom logo and transceiver name) that is displayed at power ON can be skipped, if desired.

- ON : Opening logo is displayed at power ON. (default)
- OFF : Opening logo indication is skipped.

### ◇ Opening call sign

 Available only when the UT-123 is installed.

The set your own call sign, programmed in my call sign, can be displayed at power ON. (default: OFF)

### ◇ Scan name

The programmed scan or bank name is displayed during the scan type selection.

- ON : The programmed scan or bank name is displayed. (default)
- OFF : The programmed scan or bank name is not displayed.

### ◇ RX Call Sign Display

 Available only when the UT-123 is installed.

When a call is received, the calling station call sign can be indicated automatically. (default: AUTO)

### ◇ TX Call Sign Display

 Available only when the UT-123 is installed.

Selects call sign display function from YOUR, MY and OFF. When this setting is set to YOUR or MY, the transceiver automatically indicates the set station or your own call sign at DV mode transmission. (default: YOUR)

### ◇ RX message Display

 Available only when the UT-123 is installed.

Sets auto received message display function AUTO and OFF. When this setting is set to AUTO, the transceiver automatically displays and scrolls the received message. (default: AUTO)

---

## 14 MENU SCREEN OPERATION

### ■ SOUND items

#### ◇ Key-touch beep

The key-touch beep can be turned OFF for silent operation.  
(default: ON)

#### ◇ Beep level

Adjusts the key-touch beep tone level to the desired level from 9 levels.

- 1 (Minimum level) to 9 (Maximum level) (default: 9)

/// The key-touch beep function must be set to ON to have a beep tone.

#### ◇ Scope AF output

Select the audio output function capability during sweep with band scope function.

- ON : The received audio sounds during sweep.  
(default)
- OFF : No audio sounds during sweep.

#### ◇ Sub band mute

Turns the sub band mute function capability ON and OFF (default).

#### ◇ Sub band beep

Turns the sub band busy beep function capability ON and OFF (default).

#### ◇ Standby Beep

 Available only when the UT-123 is installed.

Turns the beep emission capability ON and OFF when the communicating station finishes transmitting or the receive signal disappears while in the DV mode operation. (default: ON)

## ■ DV GPS items

### ◇ GPS sentence

- ① Enter MENU screen via function guide.
  - ➔ Push **[F•---**] to display function guide.
  - ➔ Push **[MENU](V/MHz•SCAN)** (Right band's) to enter MENU screen.
- ② Rotate **[DIAL]** to select "DV GPS," then push **[MAIN•BAND]** to enter DV GPS set mode.
- ③ Rotate **[DIAL]** to select "GPS SENTENCE," then push **[MAIN•BAND]** to enter sentence formatter selection mode.
- ④ Rotate **[DIAL]** to select the desired sentence formatter.
  - RMC, GGA, GLL, GSA and VTG are selectable.
- ⑤ Push **[MAIN•BAND]** to enter the desired sentence formatter selection.
- ⑥ Rotate **[DIAL]** to select the setting ON and OFF, then push **[MAIN•BAND]**.
- ⑦ Rotate **[DIAL]** to select next sentence and repeat steps ④ to ⑥, or push **[BACK](V/MHz•SCAN)** (Right band's) three times to return to frequency indication.
  - Only three sentence formatters can be activated at the same time.

### ◇ GPS message

Sets the GPS message for transmission. The stored message is transmitted with position data.

See p. 128 in chapter 16 for details.

### ◇ RX GPS message

Shows the received GPS message.

See p. 130 in chapter 16 for details.

### ◇ GPS TX

Sets position data transmission usage from "GPS-A," "GPS" and "DISABLE."  
(default: DISABLE)

### ◇ GPS auto TX

Selects the desired interval for automatic position transmission function from 5, 10, 30 second, 1, 3, 5, 10 and 30 minutes.  
(default: OFF)

### ■ PACKET items

#### ◇ Packet BPS

Selects the data transmission speed for packet operation from 1200 bps (default) and 9600 bps.

#### ◇ Packet operation band

Selects the packet operation band from main, right and left.

- MAIN : The main band is used for packet operation. (default)
- L (Left)/R (Right) : The selected left or right band can only be operated for packet.

### ■ GPS SET MODE items

#### ◇ GPS SPEED

Selects the data transmission speed for packet operation from 4800 bps (default) and 9600 bps.

#### ◇ Display units

Selects display units for distance and elevation from “m” or “ft/ml.”

(default : USA/General versions; ft/ml, Other versions; m)

#### ◇ Compass type

Selects compass indication type from “ARROWHEAD” (default), “NORTH REF” and “SOUTH REF.”

#### ◇ UTC offset

Sets time difference from UTC (Universal Time Coordinated) within -12:00 to +12:00 range in 5 min. steps. (default: 0:00)

#### ◇ GPS datum

Selects the GPS datum (country/area code) from 0 (default) to 224.

If wrong GPS datum (country/area code) is set, the position measuring accuracy may be poor.

### ◆ Alarm area 1

Sets GPS alarm active range within 00'05" to 59'59" in 1 sec. (00'01") steps. (default: 00'15")

- ① Push **[MAIN•BAND]** to enter alarm area programming condition.
- ② Rotate **[DIAL]** to set the desired range.
  - Push **[mm](V/MHz•SCAN)** (Left band's) or **[ss](M/CALL•MW)** (Left band's) to select minutes or second digits, respectively.
- ③ Push **[MAIN•BAND]** to fix the setting.

• **Example:** Your position : 35°N/135°E  
 ALM AREA1 setting : 00'15" (default)

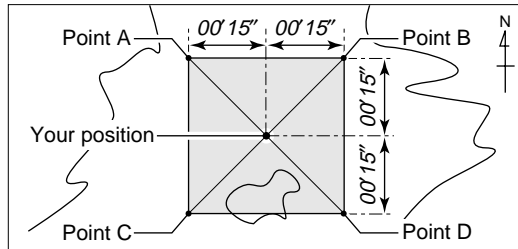

- Position of point A : 35°00'15"N/134°59'45"E
- Position of point B : 35°00'15"N/135°00'15"E
- Position of point C : 34°59'45"N/134°59'45"E
- Position of point D : 34°59'45"N/135°00'15"E

When the target position is coming into the area as above, the GPS alarm will be sound.

### ◆ Alarm area 2

Selects GPS alarm active range from "LIMITED," "EXTENDED" and "BOTH."

- **LIMITED** : GPS alarm will be sound when a target position is coming into 500 m\* (547 Y)\* range.
- **EXTENDED** : GPS alarm will be sound when a target position is coming into 1 km\* (1094 Y)\* range.
- **BOTH** : GPS alarm will be sound when a target position is coming into both 500 m\* (547 Y)\* and 1 km\* (1094 Y)\* range. (default)

• **Example:**

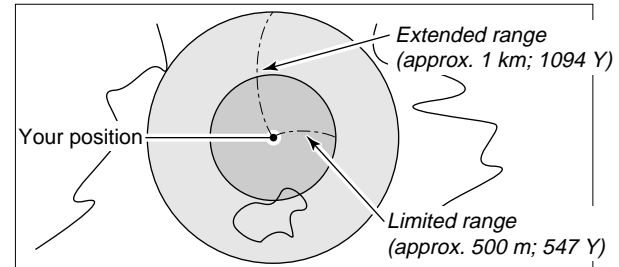

When the target position is coming into either/each area as above, the GPS alarm will be sound.

\*Approximate

### ■ GPS-A SET MODE items

#### ◇ Unproto address

Sets up to 56-character unproto address.

- ① Push **[MAIN•BAND]** to enter programming condition.
- ② Rotate **[DIAL]** to select the desired character.
  - Push **[Aa](TONE•DTMF)** to select the character group from capital letters or lower case letters.
  - Push **[1/](M/CALL•MW)** (Right band's) to select the character group from numbers or symbols.
  - Push **[>](M/CALL•MW)** (Left band's) or **[<](V/MHz•SCAN)** (Left band's) to move the cursor right or left, respectively.
  - Push **[CLR](DUP/MONI)** to clear the selected character.
  - Push and hold **[CLR](DUP/MONI)** for 1 sec. to clear all characters after the selected character.
- ③ Repeat steps ② until the desired address is programmed.
- ④ Push **[MAIN•BAND]** to set the programmed address.
- ⑤ Push **[BACK](V/MHz•SCAN)** (Right band's) to return to the GPS-A set mode screen.

#### ◇ Data extension

Sets the data extension capability from "COURSE/SPEED" and OFF (default).

The transceiver's course and speed information is additionally transmitted with position data when "COURSE/SPEED" is selected.

/// **NOTE:** When "COURSE/SPEED" is selected, number of character for "COMMENT" is limited to 36-character.

#### ◇ Time stamp

Selects transmitting time stamp type from DHM, HMS and OFF. This function can be transmitted UTC (Universal Time Co-ordinated) time only.

- OFF : No time stamp is transmitted. (default)
- DHM : Time stamp in the format of Day, Hour and Minute is transmitted.
- HMS : Time stamp in the format of Hour, Minute and Second is transmitted.

#### ◇ GPS-A symbol

Selects the desired GPS-A symbol.

**Available symbols:** Ambulance, Bus, Fire Truck, Bicycle, Yacht, Helicopter, Small Aircraft, Ship (Power Boat), Car (default), Motorcycle, Balloon, Jeep, Recreational Vehicle, Truck, Van, Other

If "Other" is selected, set the desired symbol code as follows;

- ① Push **[MAIN•BAND]** to enter programming condition.
- ② Rotate **[DIAL]** to select the 1st character from "A" and "Z".
- ③ Push **[>](M/CALL•MW)** (Left band's) to select the 2nd digit.
- ④ Rotate **[DIAL]** to select the 2nd digit character.
- ⑤ Push **[MAIN•BAND]** to program the symbol code.

/// When "Other" is selected, check the symbol codes of APRS,® and set it correctly.

## ◇ Comment

Program up to a 43-character\* comment. The programmed comment is transmitted with the GPS position data.

\*36-character comment can only be programmed when "COURSE/SPEED" is selected in data extension.

- ① Push **[MAIN•BAND]** twice to enter programming condition.
- ② Rotate **[DIAL]** to select the desired character.
  - Push **[Aa](TONE•DTMF)** to turn the character group from alphabetical characters capital letters or lower case letters.
  - Push **[1/](M/CALL•MW)** (Right band's) to turn the character group from numbers or symbols.
  - Push **[>](M/CALL•MW)** (Left band's) or **[<](V/MHz•SCAN)** (Left band's) to move the cursor right or left, respectively.
  - Push **[CLR](DUP/MONI)** to clear the selected character.
  - Push and hold **[CLR](DUP/MONI)** for 1 sec. to clear all characters after the selected character.
- ③ Repeat steps ② until the desired comment is programmed.
- ④ Push **[MAIN•BAND]** to set the programmed comment.
- ⑤ Push **[BACK](V/MHz•SCAN)** (Right band's) to return to the GPS-A set mode screen.

# 15 OTHER FUNCTIONS

## ■ Microphone keys

The supplied HM-133's (optional for some versions) [F-1] and [F-2] keys memorize the transceiver conditions.

The [UP]/[DN] keys of the standard or an optional microphone (other than the HM-133) can be assigned functions like the function keys on the transceiver's front panel.

### ◇ [F-1]/[F-2] keys on HM-133

The following conditions in the main band or both left and right bands can be memorized into [F-1] and [F-2] keys, independently.

Operating frequency, Mode (VFO/Memory/Call channel with channel number), Memory name, Repeater setting (offset direction and frequency, tone ON/OFF and frequency), Transmit output power level, Tone/DTCS squelch (ON/OFF, frequency/code and polarity), Tuning step, weather alert (USA version only), Operating mode selection (FM/FM-N/AM/AM-N/DV<sup>†</sup>), Call sign (station and repeater),<sup>†</sup> Call sign/digital code squelch (ON/OFF and digital code),<sup>†</sup> Set mode settings,\* GPS set mode settings,\* GPS-A set mode settings,\* Display set mode settings,\* Sounds set mode settings,\* DV set mode settings,\*<sup>†</sup>

\*Only when storing both band's conditions

<sup>†</sup>Available only when optional UT-123 is installed.

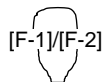

#### ➔ **Programming the main band condition**

Set the desired contents of each condition in the main band, then push [F-1]/[F-2] for 1 sec.  
• 3 beeps sound.

#### ➔ **Recalling the main band condition**

Push [F-1]/[F-2] momentarily.

#### ➔ **Programming the both bands condition**

After setting the desired contents of each condition in the both bands, push [FUNC] then push [F-1]/[F-2] for 1 sec.  
• 3 beeps sound.

#### ➔ **Recalling the both bands condition**

Push [FUNC] then [F-1]/[F-2] momentarily.

### ◇ [UP]/[DN] keys on a microphones (other than HM-133)

The following functions are assigned to the [UP]/[DN] keys on the other microphones (HM-154, etc.) in set mode.

#### • **Default setting**

[UP] : channel up; push and hold to start scan, push again to stop scan.

[DN] : channel down; push and hold to start scan, push again to stop scan.

See page 102 for assignable function details.

## ■ All reset

AT POWER ON

The function display may occasionally display erroneous information (e.g. when first applying power). This may be caused externally by static electricity or by other factors.

If this problem occurs, turn power OFF. After waiting a few seconds, turn power ON again. If the problem persists, perform the following procedure.

- Partial reset is also available. See right for details.

### /// IMPORTANT!:

Resetting the transceiver **CLEARs** all memory information and initializes all values in the transceiver.

- ➔ While pushing both band's **[M/CALL•MW]**, turn the power ON to reset the CPU.

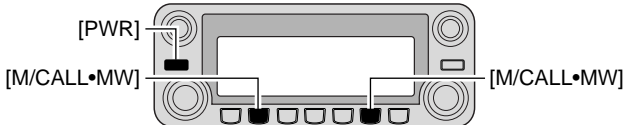

While pushing both [M/CALL•MW], turn power ON.

## ■ Partial reset

AT POWER ON

If you want to initialize the operating conditions (VFO frequency, VFO settings, menu group's contents) without clearing the memory contents, a partial reset function is available.

- ➔ While pushing either band's **[V/MHz•SCAN]**, turn the power ON to partially reset the transceiver.

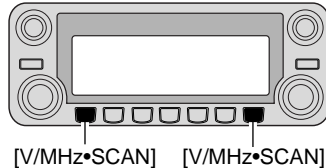

## 15 OTHER FUNCTIONS

### ■ Data cloning

AT POWER ON

Cloning allows you to quickly and easily transfer the programmed contents from one transceiver to another; or, data from a personal computer to a transceiver using the optional CS-2820 CLONING SOFTWARE.

#### ◇ Cloning between transceivers

- ① Connect the optional OPC-474 cloning cable to the [SP-2] jack of the master and sub-transceivers.
  - The master transceiver is used to send data to the sub-transceiver.

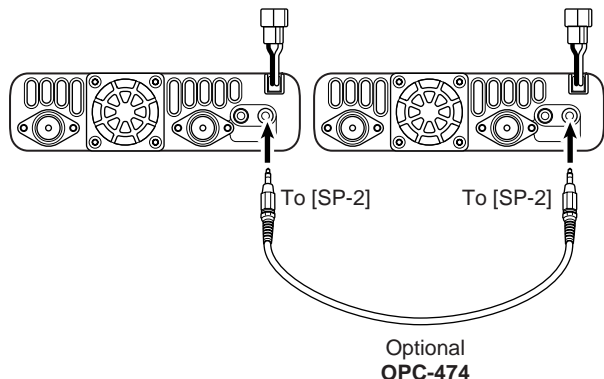

- ② While pushing right band's **[M/CALL•MW]**, turn power ON to enter cloning mode (master transceiver only— power on only for sub-transceiver).
  - “CLONE” and “M” appear and the transceivers enter the clone standby condition.

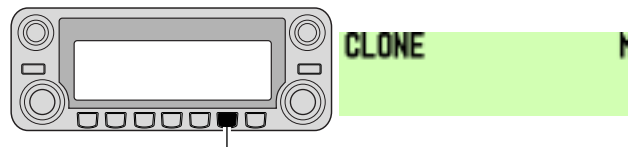

While pushing right band's **[M/CALL•MW]**, turn power ON.

- ③ Push **[M/CALL•MW]** (Right band's) on the master transceiver.
  - “CLONE OUT” appears in the master transceiver's display and the bar meter shows that data is being transferred to the sub-transceiver.
  - “CLONE IN” appears automatically in the sub-transceiver's display and the bar meter shows that data is being received from the master transceiver.

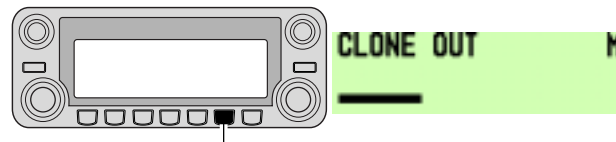

Pushing right band's **[M/CALL•MW]** start cloning.

- ④ When cloning is finished, turn power OFF, then ON to exit cloning mode.

◇ Cloning using a personal computer

Data can be cloned to and from a personal computer (Microsoft® Windows® 98SE/2000/Me/XP) using the optional CS-2820 CLONING SOFTWARE and the optional data communication cable; OPC-1529R, cloning cable; OPC-478/478U. Consult the CS-2820 CLONING SOFTWARE HELP file for details.

/// **NOTE:** If you want to clone by connecting the optional data communication cable (OPC-1529R) to the [DATA] jack, remove such as external speaker from [SP-2], if connected. Otherwise data cloning may not work properly.

◇ Cloning error

/// **NOTE: DO NOT** push any key on the transceiver (to be cloned) during cloning. This will cause a cloning error.

When the display appears as below, a cloning error has occurred.



If this happens, turn the transceiver (to be cloned) power OFF then ON again and cloning must be repeated.

■ Auto power OFF

The transceiver can be set to automatically turn OFF after a specified period with a beep when no switch is pushed.

120 min., 90 min., 60 min., 30 min. and OFF can be specified. The specified period is retained even when the transceiver is turned OFF by the auto power-off function. To cancel the function, select "OFF" in the auto power-off item in set mode.

This can be selected with "AUTO POWER OFF" in set mode. (p. 101)

■ Time-out timer

To prevent accidental prolonged transmission, etc., the transceiver has a time-out timer. This timer cuts a transmission OFF after 3, 5, 15 or 30 min. of continuous transmission. This timer can be cancelled (default).

/// Approx. 10 sec. before the time-out timer is activated, the transceiver emits a beep tone as a warning.

This can be selected with "TIME-OUT TIMER" in set mode. (p. 101)

### ■ Packet operation

#### ◇ Data speed

For packet operation, the transceiver can be set to one of two data speeds: 1200 bps (default) or 9600 bps.

- ① Push **[F•→•]** to display function guide.
- ② Push **[MENU](V/MHz•SCAN)** (Right band's) to enter MENU screen.
- ③ Rotate **[DIAL]** to select "PACKET" then push **[MAIN•BAND]**.
- ④ Rotate **[DIAL]** to select "PACKET BPS" then push **[MAIN•BAND]**.
- ⑤ Rotate **[DIAL]** to select desired data transmission speed from 1200 bps (default) and 9600 bps, then push **[MAIN•BAND]**.
- ⑥ Push **[BACK](V/MHz•SCAN)** (Right band's) twice to return to frequency indication.

#### ▨ For 1200 bps operation—

- Disconnect the microphone plug from the microphone connector during data transmission, otherwise the data signal and voice signal are simultaneously transmitted.

#### ▨ For 9600 bps operation—

- When the transceiver is set for 9600 bps data transmission in set mode, the microphone signal is automatically cut. Therefore, it is not necessary to disconnect the microphone plug from the connector in this case.
- When pushing [PTT] during data transmission, data transmission is interrupted and voice signals have priority.

#### ◇ PACKET JACK PIN ASSIGNMENT

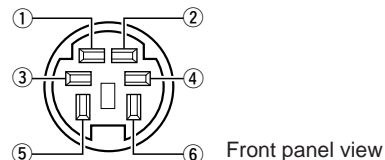

- ① DATA IN  
Input terminal for data transmit. See left for details on how to toggle data speed between 1200 (AFSK) and 9600 bps (G3RUH, GMSK).
- ② GND  
Common ground for DATA IN, DATA OUT and AF OUT.
- ③ PTT P  
PTT terminal for packet operation only. Connect ground to transmit data.
- ④ DATA OUT  
Data out terminal for 9600 bps operation only.
- ⑤ AF OUT  
Data out terminal for 1200 bps operation only.
- ⑥ P SQL  
Output is high (+5 V) when the transceiver receives a signal which opens the squelch.
  - To avoid unnecessary TNC transmission, connect squelch to the TNC to inhibit transmission when receiving signals.
  - Keep audio output at a normal level, otherwise a "P SQL" signal will not be output.

### ◇ 1200 bps packet operation

① Connect the transceiver and a TNC as illustrated below.

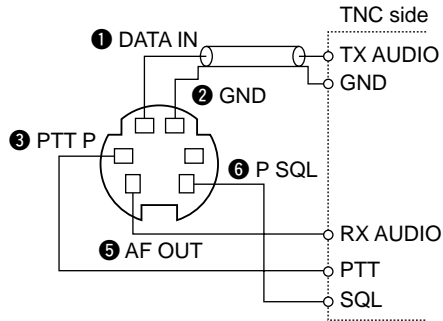

② Set the TNC for transmit.

③ Set transmit delay on the TNC to 50–100 msec., if available.

④ Adjust the TNC frequency deviation if necessary.

- **When using a deviation meter:**

Adjust the output of the TNC so that frequency deviation is in the range  $\pm 3$  to  $\pm 4$  kHz.

- **When NOT using a deviation meter:**

A receiver or transceiver is needed to monitor the transmission—compare the received audio output level when receiving a TNC modulated signal with high level voice signals using the microphone. Then adjust the TNC modulated signal to a lower level than the voice modulated signal.

- Read the instructions supplied with your TNC carefully before attempting packet operation with the transceiver.
- Pin ⑤ AF OUT is for 1200 bps operation only. This pin cannot be used for 9600 bps operation.
- Over modulation may degrade signal quality. If you find that many transmissions are failing, re-adjust the modulation level.

## 15 OTHER FUNCTIONS

### ◇ 9600 bps high speed packet operation

The transceiver supports 2 modes of 9600 bps packet operation: G3RUH and GMSK.

① Connect the transceiver and a TNC as illustrated below.

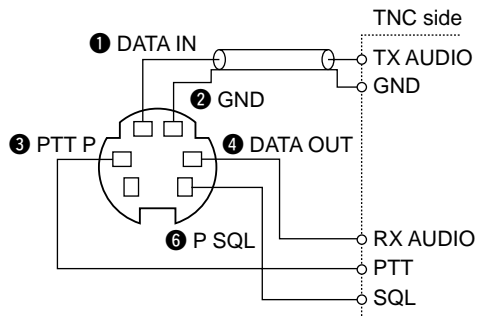

- ② G3RUH mode can handle 16 kinds of modulated wave forms in order to maintain a communication link.
- ③ Set transmit delay on the TNC to 50–100 msec., if available.
- ④ Adjust the TNC frequency deviation if necessary (see page at right).

- When using the PTT P terminal for packet operation, no voice signals are transmitted from the microphone.
- When pushing [PTT] during data transmission, data transmission is interrupted and the voice signal takes priority.
- Read the instructions supplied with your TNC carefully before attempting packet operation with the transceiver.
- Pin ④ DATA OUT is for 9600 bps operation only. This pin cannot be used for 1200 bps operation.

### ◇ Adjusting the transmit signal output from the TNC

When setting data transmission speed to 9600 bps, the data signal coming from the TNC is applied exclusively to the internal limiter circuitry to automatically maintain band width.

**NEVER** apply data levels from the TNC of over 0.6 V p-p, otherwise the transceiver will not be able to maintain the band width and may possibly interfere with other stations.

#### 1. When using a level meter or oscilloscope, adjust the TX audio output level (DATA IN level) from the TNC as follows.

0.4 V p-p (0.2 V rms) : recommended level

0.2 V p-p–0.5 V p-p (0.1–0.25 V rms) : acceptable level

#### 2. When NOT using a measuring device.

- ① Connect the transceiver to a TNC.
- ② Enter a test mode (“CALL”, etc.) on the TNC, then transmit some test data.
- ③ *When the transceiver fails to transmit the test data or transmits sporadically (TX indicator doesn't appear or flashes):*
  - Decrease the TNC output level until the transmit indicator lights continuously.

*When transmission is not successful even though the TX indicator lights continuously:*

  - Increase the TNC output level.

### ◇ Packet operation band selection

Both bands, or either the left or right band only, can be specified for packet operation to suit your preference.

- ① Push **[F•---•]** to display function guide.
- ② Push **[MENU](V/MHz•SCAN)** (Right band's) to enter MENU screen.
- ③ Rotate **[DIAL]** to select “PACKET” then push **[MAIN•BAND]**.
- ④ Rotate **[DIAL]** to select “PACKET BAND” then push **[MAIN•BAND]**.
- ⑤ Rotate **[DIAL]** to select desired band from MAIN (default), left (L) and right (R), then push **[MAIN•BAND]**.
  - MAIN : The main band is used for packet operation.
  - Left (L)/Right (r) : The selected left or right band can only be used for packet operation.
- ⑥ Push **[BACK](V/MHz•SCAN)** (Right band's) twice to return to frequency indication.

## 15 OTHER FUNCTIONS

### ■ Weather channel operation

USA version only

#### ◇ Weather channel selection

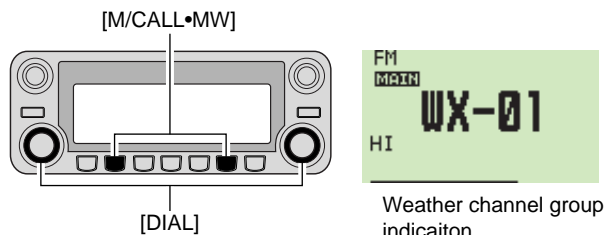

Weather channel group indication

- ① Push the desired band's **[M/CALL•MW]** several times to select weather channel group.
- ② Rotate the same band's **[DIAL]** to select the desired weather channel.
- ③ Push the **[M/CALL•MW]** to select memory mode, or push the same band's **[V/MHz•SCAN]** to select VFO mode.

#### ◇ Weather alert function

NOAA broadcast stations transmit weather alert tones before important weather announcements. When the weather alert function is turned ON, the selected weather channel is monitored every 5 sec. so you can hear weather announcements. When the alert signal is detected, the "ALT" and the "WX" with channel number are displayed alternately and sounds a beep tone until the transceiver is operated. The previously selected (used) weather channel is checked periodically during standby or while scanning.

- ① Select the desired weather channel.
- ② Turn the weather alert function ON in DUP/TONE set mode.
  - ① Push **[F•T•O]** to display function guide.
  - ② Push **[MENU](V/MHz•SCAN)** (Right band's) to enter MENU screen.
  - ③ Rotate **[DIAL]** to select "DUP/TONE..." then push **[MAIN•BAND]**.
  - ④ Rotate **[DIAL]** to select "WX ALERT" then push **[MAIN•BAND]**.
  - ④ Rotate **[DIAL]** to select "ON" then push **[MAIN•BAND]**.
  - ⑤ Push **[BACK](V/MHz•SCAN)** (Right band's) twice to exit from DUP/TONE set mode.
- ③ Sets the desired stand-by condition.
  - Selects VFO, memory or call channel.
  - Scan or priority watch operation can also be selected.
- ④ When the alert is detected, a beep sounds and the following indication will be displayed.

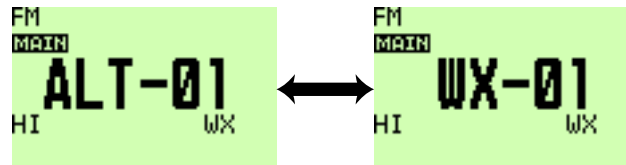

The display shows above indications alternately.

- ⑤ Turn the weather alert function OFF in DUP/TONE set mode.

**NOTE:** While receiving a signal (on a frequency other than the weather alert ON frequency), the receiving signal or audio will be interrupted momentarily every 5 sec. (approx.) in case the alert function is turned ON. This symptom is caused by the WX alert function. To cancel these symptoms, set the weather alert item OFF in "DUP/TONE" set mode.

# 16 GPS/GPS-A OPERATION

## ■ GPS operation

A GPS receiver is built-in to the optional UT-123. When UT-123 is installed, GPS operation that indicate the current position (Latitude and Longitude) and time is available. The position data can also be transmitted with a message to another station.

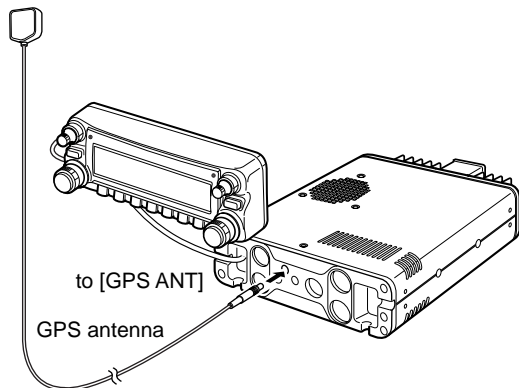

GPS antenna cable length: approx. 5 m (16.4 ft)

## ◇ GPS function

- ① While in DV mode operation, push **[E•T-O]** to display the function guide.
- ② Push **[MENU](V/MHz•SCAN)** (Right band's) to enter MENU screen.

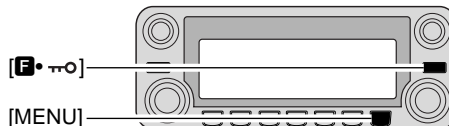

- ③ Rotate **[DIAL]** to select "SET MODE," then push **[MAIN•BAND]** to enter set mode.
- ④ Rotate **[DIAL]** to select "GPS" then push **[MAIN•BAND]**.
- ⑤ Rotate **[DIAL]** to turn the GPS function ON and OFF, then push **[MAIN•BAND]**
  - Select "OFF" to deactivate the GPS function.

MENU	AUTO ATT	OFF	▲
	ALC	OFF	
	DIVERSITY	OFF	
SET MODE	GPS	ON	■
12/14	HM-154 UP	MIC-UP	▼
		BACK	

- ⑥ Push **[BACK](V/MHz•SCAN)** (Right band's) twice to return to frequency indication.
- “GPS” indicator stays ON when GPS signal is received, or blinks when GPS signal cannot be received.

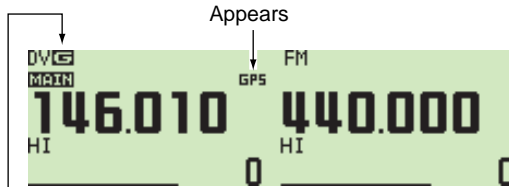

“G” appears when GPS TX is set to GPS.  
 “A” appears when GPS TX is set to GPS-A.  
 No indication appears when GPS TX is set to DISABLE.  
 (GPS TX is described on pages 110 and 127.)

### ◇ Sentence formatters selection

- ① Enter MENU screen via function guide.
  - ➔ Push **[F•M•O]** to display function guide.
  - ➔ Push **[MENU](V/MHz•SCAN)** (Right band's) to enter MENU screen.
- ② Rotate **[DIAL]** to select “DV GPS,” then push **[MAIN•BAND]** to enter DV GPS set mode.
- ③ Rotate **[DIAL]** to select “GPS SENTENCE,” then push **[MAIN•BAND]** to enter sentence formatter selection mode.

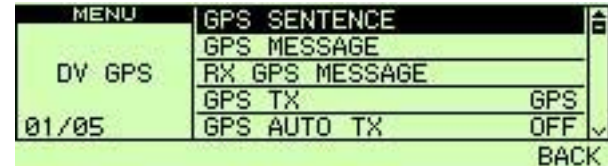

- ④ Rotate **[DIAL]** to select the desired sentence formatter.
  - RMC, GGA, GLL, GSA and VTG are selectable.
- ⑤ Push **[MAIN•BAND]** to enter the desired sentence formatter selection.
- ⑥ Rotate **[DIAL]** to select the setting ON and OFF, then push **[MAIN•BAND]**.
- ⑦ Rotate **[DIAL]** to select next sentence and repeat steps ④ to ⑥, or push **[BACK](V/MHz•SCAN)** (Right band's) three times to return to frequency indication.
  - Only three sentence formatters can be activated at the same time.

## 16 GPS/GPS-A OPERATION

### ◆ Position indication

- ① Push **[F•T•O]** several times to display function guide 3.
- ② Push **[POS](M/CALL•MW)** (Left band's) once to display the "POSITION" screen.
- ③ Push and hold **[G-WR](DUP•MONI)** for 1 sec. to store the your current position information, if desired.
- ④ Push **[F•T•O]** once to return to frequency indication.

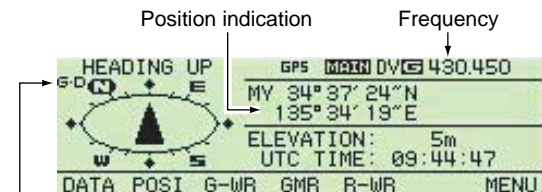

"G-D" appears when GPS data communication is set to ON.

### ◆ GPS data communication

The transceiver transmits a GPS data or DV data to your connecting PC via the **[DATA]** jack depending on the data communication setting.

- While in DV mode operation and displayed position indication as above, push **[DATA](V/MHz•SCAN)** (Left band's) to toggle the GPS data communication ON and OFF.
  - ON : GPS data from the connected GPS receiver.
  - OFF: DV data such as the low-speed data communication data (p. 57) or received position data (p. 129).

### ◆ GPS Automatic transmission

- ① Enter MENU screen via function guide.
  - Push **[F•T•O]** to display function guide.
  - Push **[MENU](V/MHz•SCAN)** (Right band's) to enter MENU screen.
- ② Rotate **[DIAL]** to select "DV SET MODE," then push **[MAIN•BAND]** to enter DV set mode.
- ③ Rotate **[DIAL]** to select "DV DATA TX," then push **[MAIN•BAND]**.
- ④ Rotate **[DIAL]** to select "AUTO," then push **[MAIN•BAND]**.

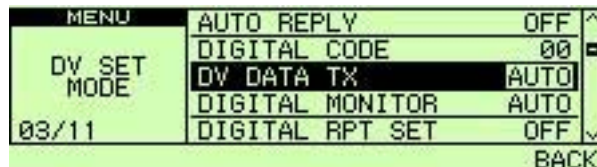

- ⑤ Push **[BACK](V/MHz•SCAN)** (Right band's) to return to MENU screen.
- ⑥ Rotate **[DIAL]** to select "DV GPS," then push **[MAIN•BAND]** to enter DV GPS set mode.
- ⑦ Rotate **[DIAL]** to select "GPS TX," then push **[MAIN•BAND]**.
- ⑧ Rotate **[DIAL]** to select "GPS," then push **[MAIN•BAND]**.

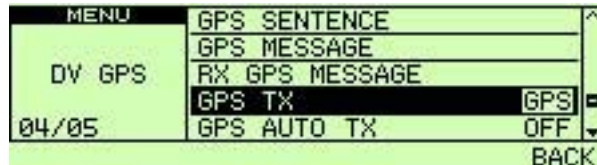

- ⑨ Rotate **[DIAL]** to select “GPS AUTO TX,” then push **[MAIN•BAND]** to enter GPS auto transmission interval.

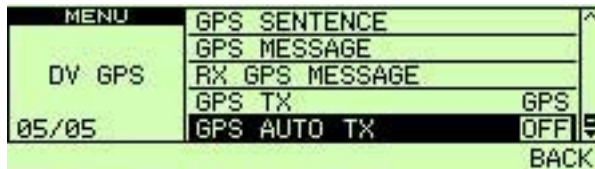

- ⑩ Rotate **[DIAL]** to select the desired auto transmission interval.  
 • 5SEC, 10SEC, 30SEC, 1MIN, 3MIN, 5MIN, 10MIN and 30MIN are selectable.
- ⑪ Push **[BACK](V/MHz•SCAN)** (Right band's) three times to return to frequency indication.

### ◇ GPS message programming

- ① Enter MENU screen via function guide.  
 ➔ Push **[F•→]** to display function guide.  
 ➔ Push **[MENU](V/MHz•SCAN)** (Right band's) to enter MENU screen.
- ② Rotate **[DIAL]** to select “DV GPS,” then push **[MAIN•BAND]** to enter DV GPS set mode.
- ③ Rotate **[DIAL]** to select “GPS MESSAGE,” then push **[MAIN•BAND]**.

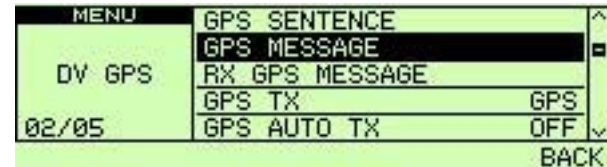

- ④ Push **[MAIN•BAND]** to enter message programming mode.

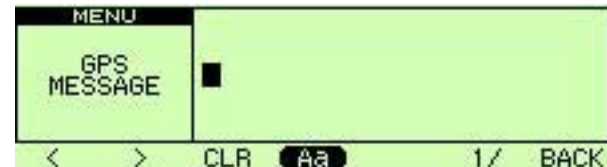

- The cursor appears on the first character.

## 16 GPS/GPS-A OPERATION

- ⑤ Rotate **[DIAL]** to select the desired character.
  - Push **[Aa](TONE•DTMF)** to select the character group from capital letters or lower case letters.
  - Push **[1/](M/CALL•MW)** (Right band's) to select the character group from numbers or symbols.
  - Push **[>](M/CALL•MW)** (Left band's) to move the cursor right; push **[<](V/MHz•SCAN)** (Left band's) to move the cursor left.
  - Push **[CLR](DUP/MONI)** to clear the selected character.
  - Push and hold **[CLR](DUP/MONI)** for 1 sec. to clear all characters after the selected character.
- ⑥ Push **[MAIN•BAND]** to set the message.
  - The cursor disappears.
- ⑦ Push **[F••••]** once to return to frequency indication.

### ◆ Receiving a GPS transmission

- ① While in DV mode operation, push **[F••••]** three times to display function guide 3.
- ② Push **[POSI](M/CALL•MW)** (Left band's) twice to display the "RX POSITION" screen.
- ③ Push and hold **[R-WR](LOW•PRIO)** for 1 sec. to store the received position information.
- ④ Push **[F••••]** once to return to frequency indication.

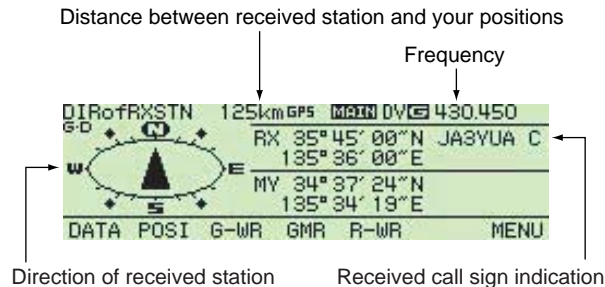

### ✓ For your information!

The position display of a received signal is available only if the transmitting station is using at least one of the following sentence formatters; RMC, GGA, or GLL.

### ◇ RX GPS message indication

- ① Enter MENU screen via function guide.
  - ➔ Push **[F••••]** to display function guide.
  - ➔ Push **[MENU](V/MHz•SCAN)** (Right band's) to enter MENU screen.
- ② Rotate **[DIAL]** to select “DV GPS,” then push **[MAIN•BAND]** to enter DV GPS set mode.
- ③ Rotate **[DIAL]** to select “RX GPS MESSAGE,” then push **[MAIN•BAND]** to enter received GPS message.

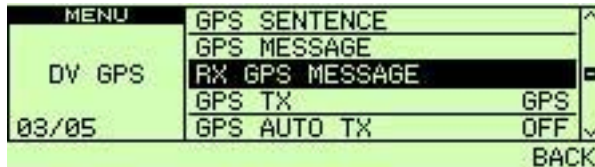

- ④ Verify the received GPS message.
- ⑤ Push **[F••••]** once to return to frequency indication.

### ◇ Programming GPS memory

Each memory channel can be programmed with an alphanumeric channel name for easy recognition and can be displayed independently by channel. Names can be a maximum of 8 characters— see the table on page 66 for available characters.

- ① Push **[GMR](TONE•DTMF)** to select GPS memory mode.
- ② Rotate **[DIAL]** to select “ALL,” then push **[MAIN•BAND]**.
- ③ Rotate **[DIAL]** to select the desired GPS memory channel, then push **[MAIN•BAND]**.
  - “NAME” : The GPS memory name
  - “TIME” : Time data
  - “LAT” : Latitude data
  - “LOT” : Longitude data
  - “BANK” : The memory bank
- ④ Push **[MAIN•BAND]** to enter memory programming mode.
  - The cursor appears on the NAME’s first character.
- ⑤ Rotate **[DIAL]** to select the desired character.
  - Push **[Aa](TONE•DTMF)** to turn the character group from alphabetical characters capital letters or lower case letters.
  - Push **[1/](M/CALL•MW)** (Right band's) to turn the character group from numbers or symbols.
  - Push **[>](M/CALL•MW)** (Left band's) to move the cursor right; push **[<](V/MHz•SCAN)** (Left band's) to move the cursor left.
  - Push **[CLR](DUP/MONI)** to clear the selected character.
  - Push and hold **[CLR](DUP/MONI)** for 1 sec. to clear all characters after the selected character.
- ⑥ Push **[MAIN•BAND]** to set the channel.
  - The cursor disappears.

## 16 GPS/GPS-A OPERATION

### ◆ GPS alarm setting

GPS alarm sounds when your own position is close the specified area. This function can be set the received channel, specified GPS memory channel, all GPS memory channels or a memory bank.

- ① Push **[GMR](TONE•DTMF)** to select GPS memory mode.
- ② Rotate **[DIAL]** to select the desired memory group, or memory channel.
  - “RX,” “ALL,” one of memory bank or memory channel can be selected.
- ③ Push **[ALM](TONE•DTMF)** to turn the alarm function ON.
  - Push **[ALM](TONE•DTMF)** again or push **[Aoff](LOW•PRIO)** to turn OFF the alarm function.

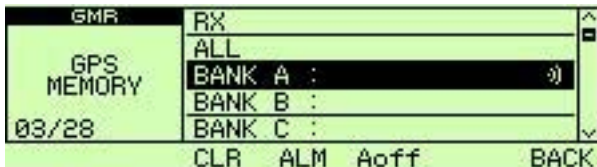

- ④ Push **[BACK](V/MHz•SCAN)** (Right band's) once or twice to return to frequency indication.

#### ✓ For your information!

- When “RX” or memory channel is selected above step ②, alarm functions depending on “ALM AREA2” setting in the GPS set mode (p. 112).
- When “ALL” or memory bank is selected above step ②, alarm functions depending on “ALM AREA1” setting in the GPS set mode (p. 112).

### ◆ GPS memory clearing

- ① Push **[GMR](TONE•DTMF)** to select GPS memory mode.
- ② Rotate **[DIAL]** to select “ALL,” or desired memory bank, then push **[MAIN•BAND]**.
- ③ Rotate **[DIAL]** to select the desired GPS memory channel
  - “ALL” or one of memory bank can also be selected.

/// **NOTE:** When selecting “ALL” or one of the memory banks, all memory channels or all memory channels in the specified memory bank are cleared, respectively.
- ④ Push and hold **[CLR](DUP•MONI)** for 1 sec. to clear.
  - 3 beeps sound, then the memory channel is cleared.
  - Remaining channels scroll up.
- ⑤ Push **[BACK](V/MHz•SCAN)** (Right band's) twice to return to frequency indication.

/// **NOTE:** Be careful!— the contents of cleared memories CANNOT be recalled.

## ■ GPS-A operation

### ◇ GPS-A function

Set the following for activate the GPS-A function.

- ① Select the DV mode operation (p. 39)
- ② Set the GPS function ON. (p. 125)
- ③ Select the DV data transmission to AUTO. (p. 127)
- ④ Select the GPS transmission selection to GPS-A. (p. 127)
- ⑤ Set the GPS auto transmission interval. (p. 128)
- ⑥ Set the GPS-A set items. (p. 113)

### ◇ GPS-A code details

While in GPS-A operation, following codes are transmitted to your connecting PC. GPS-A code is based on APRS® code. (APRS® : Automatic Position Reporting System)

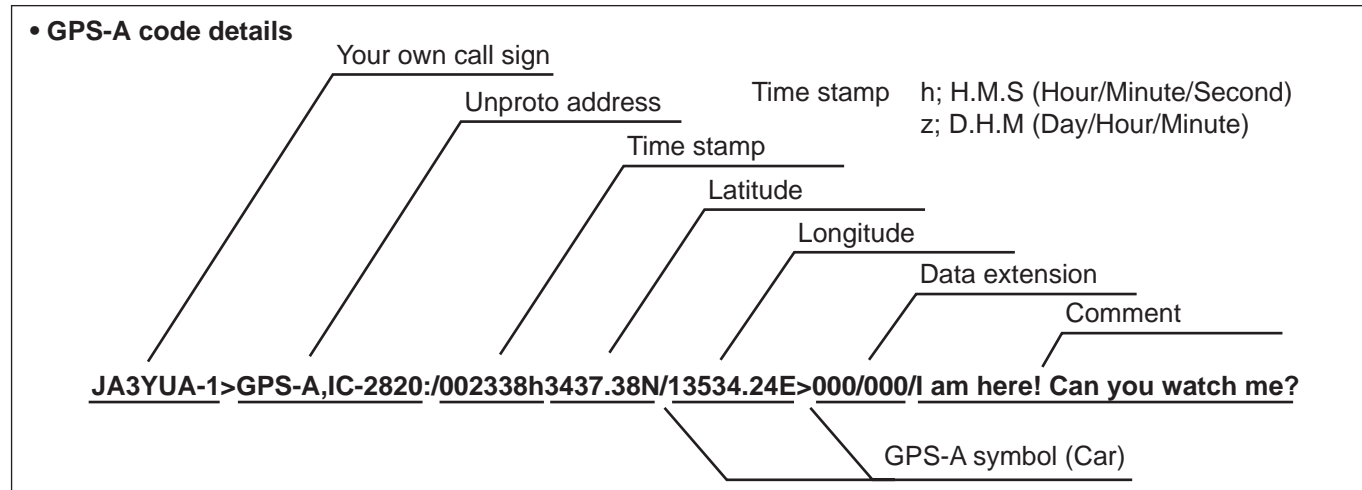

# 17 MAINTENANCE

## ■ Troubleshooting

If your transceiver seems to be malfunctioning, please check the following points before sending it to a service center.

PROBLEM	POSSIBLE CAUSE	SOLUTION	REF.
Does not turn on.	<ul style="list-style-type: none"> <li>• Power connector has a poor contact.</li> <li>• Polarity of the power connection is reversed.</li> <li>• Blown fuse.</li> </ul>	<ul style="list-style-type: none"> <li>• Check the connector pins.</li> <li>• Re-connect the power cable observing the proper polarity. Replace the fuse if damaged.</li> <li>• Check the cause, then replace the fuse.</li> </ul>	— pgs. VII, VIII, 134 p. 134
No sound comes from the speaker.	<ul style="list-style-type: none"> <li>• Volume is too low.</li> <li>• The audio mute function is activated.</li> <li>• Squelch is set too high.</li> <li>• A selective call or squelch function is activated such as pocket beep or tone squelch.</li> </ul>	<ul style="list-style-type: none"> <li>• Rotate [VOL] clockwise.</li> <li>• Push any key to deactivate it.</li> <li>• Set the squelch level to the threshold.</li> <li>• Turn the appropriate function OFF.</li> </ul>	p. 20 p. 27 p. 20 pgs. 86, 87, 91
Sensitivity is low and only strong signals are audible.	<ul style="list-style-type: none"> <li>• Antenna feedline or the antenna connector has a poor contact or is short circuited.</li> <li>• Squelch attenuator function is activated.</li> </ul>	<ul style="list-style-type: none"> <li>• Check, and if necessary, replace the feedline or solder the antenna connector again.</li> <li>• Set [SQL] between 10–12 o'clock position.</li> </ul>	p. VII p. 22
No contact possible with another station.	<ul style="list-style-type: none"> <li>• The other station is using tone squelch.</li> <li>• The transceiver is set to duplex.</li> </ul>	<ul style="list-style-type: none"> <li>• Turn the tone squelch function ON.</li> <li>• Set to simplex.</li> </ul>	p. 86 p. 30
Repeater cannot be accessed.	<ul style="list-style-type: none"> <li>• Wrong offset frequency is programmed.</li> <li>• Wrong subaudible tone frequency is programmed.</li> </ul>	<ul style="list-style-type: none"> <li>• Correct the offset frequency.</li> <li>• Correct the subaudible tone frequency.</li> </ul>	p. 34 p. 32
Frequency cannot be set.	<ul style="list-style-type: none"> <li>• The frequency lock function is activated.</li> <li>• Priority watch is paused on the watching frequency.</li> </ul>	<ul style="list-style-type: none"> <li>• Turn the function OFF.</li> <li>• Push [LOW•PRIO] for 1 sec. to cancel the watch.</li> </ul>	p. 19 p. 81
Frequency cannot be set via the microphone.	<ul style="list-style-type: none"> <li>• The frequency lock function is activated.</li> <li>• The microphone keypad lock function is activated.</li> <li>• Priority watch is paused on the watching frequency.</li> </ul>	<ul style="list-style-type: none"> <li>• Turn the function OFF</li> <li>• Push [FUNC] then [sql▼ # (16KEY-L)] to deactivate the microphone keypad lock function.</li> <li>• Push [LOW•PRIO] for 1 sec. to cancel the watch.</li> </ul>	p. 19 p. 19 p. 81

PROBLEM	POSSIBLE CAUSE	SOLUTION	REF.
Some memory channels cannot be selected via the tuning dial.	<ul style="list-style-type: none"> <li>The memory channel number has not yet been programmed.</li> </ul>	<ul style="list-style-type: none"> <li>Select the channel via the microphone keypad to check whether the channel has been programmed or not.</li> </ul>	—
Scan does not operate.	<ul style="list-style-type: none"> <li>The squelch is open.</li> <li>Only 1 memory channel is programmed or other channels are set as skip channels.</li> <li>Priority watch is activated.</li> </ul>	<ul style="list-style-type: none"> <li>Set the squelch to the threshold point.</li> <li>Program other memory channels or cancel the memory skip function in the desired channels.</li> <li>Cancel the watch.</li> </ul>	p. 22 pgs. 62, 63, 79 p. 81
Transmission is automatically cut off.	<ul style="list-style-type: none"> <li>Time-out timer is activated.</li> </ul>	<ul style="list-style-type: none"> <li>Set the timer to OFF.</li> </ul>	p. 101
Transmission continues even when the PTT is released.	<ul style="list-style-type: none"> <li>One-touch PTT function is activated.</li> </ul>	<ul style="list-style-type: none"> <li>Turn the function OFF.</li> </ul>	p. 26
During tone squelch operation, the received audio breaks off at the other station.	<ul style="list-style-type: none"> <li>Transmitter's microphone gain is too high.</li> </ul>	<ul style="list-style-type: none"> <li>Select low microphone sensitivity in set mode.</li> <li>Turn the ALC function ON in set mode.</li> </ul>	p. 102 p. 102
The function display shows erroneous information.	<ul style="list-style-type: none"> <li>The CPU is malfunctioning.</li> </ul>	<ul style="list-style-type: none"> <li>Reset the CPU.</li> </ul>	p. 116

## ■ Fuse replacement

If the fuse blows or the transceiver stops functioning, find the source of the problem if possible, and replace the blown fuse with a new, properly rated one (FGB 20 A) as shown at right.

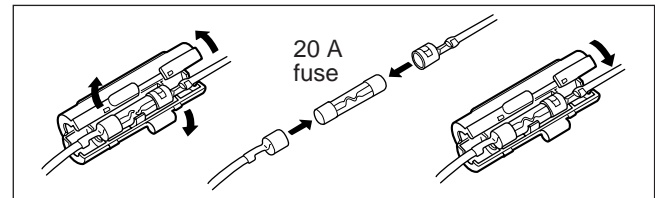

## ■ Optional UT-123 installation

### **IMPORTANT!**

Turn power OFF and disconnect the transceiver from power source before opening the top cover. Otherwise an electric shock or damage to the transceiver may occur.

Install the optional UT-123 as following procedures.

- ① Unscrew 10 screws from the top cover of the main unit then remove the top cover.

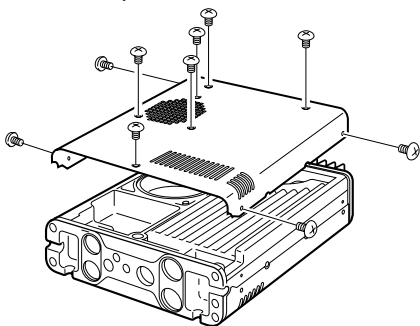

- ② Insert the UT-123 into the connector on the main unit as illustrated as below, then confirm to install it completely.

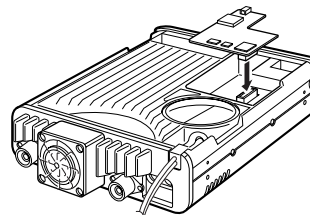

- ③ Replace the top cover and screws to the original position.

## ■ Specifications

### ◇ GENERAL

- Frequency coverage : (unit: MHz)

Version	Left Band	Right Band
<b>USA, General</b>	Rx: 118–549.995*1 Tx: 144–148, 430–450*2	Rx: 118–173.995*1, 375–549.995,*3 810–999.99*4 Tx: 144–148, 430–450*2
<b>Australia</b>	Tx/Rx: 144–148, 430–440	
<b>Taiwan</b>	Tx/Rx: 144–146, 430–432	
<b>Korea</b>	Tx/Rx: 144–146, 430–440	

\*Guaranteed: 144–148 MHz range only; \*\*Guaranteed: 440–450 MHz range for the USA, 430–440 MHz for the General version; \*3Not guaranteed; \*\*824.010 to 848.990 and 869.010 to 893.990 MHz ranges are inhibited for USA version and not guaranteed.

- Type of emission : FM, AM (Receive only), DV (optional UT-123 is required)
- Number of memory channels : 522 (incl. 20 scan edges and 2 calls)
- Frequency resolution : 5, 6.25, 10, 12.5, 15, 20, 25, 30, 50 kHz
- Operating temperature range : –10°C to +60°C; +14°F to +140°F
- Frequency stability : ±2.5 ppm (–10°C to +60°C)
- Power supply requirement : 13.8 V DC ±15%
- Current drain (at 13.8 V DC: approx.):
  - Transmit : at 50 W 13 A\*  
\* 10.5 A (at 25 W) only for the Taiwan version
  - Receive (simultaneous receive) : standby 1.2 A  
max. audio 1.8 A
- Antenna connector : SO-239 (50 Ω)×2 (Tx/Rx and Diversity)
- Dimensions (proj. not included) :
  - Main Unit : 150(W) × 40(H) × 187.7(D) mm  
5<sup>29</sup>/<sub>32</sub>(W) × 1<sup>1</sup>/<sub>16</sub>(H) × 7<sup>1</sup>/<sub>32</sub>(D) in
  - Remote controller : 150(W) × 58(H) × 31.5(D) mm  
5<sup>29</sup>/<sub>32</sub>(W) × 2<sup>3</sup>/<sub>32</sub>(H) × 1<sup>1</sup>/<sub>4</sub>(D) in
- Weight (approx.) :
  - Main unit : 1.5 kg; 3 lb 5 oz
  - Remote controller : 210 g; 7.4 oz (incl. separation cable)

### ◇ TRANSMITTER

- Modulation system : Variable reactance frequency modulation
- Output power : 50/15/5 W\* (approx.)  
\*25/15/5 W only for the Taiwan version.
- Max. frequency deviation : ±5.0 kHz (wide)  
±2.5 kHz (narrow)
- Spurious emissions : Less than –60 dB
- Microphone connector : 8-pin modular (600 Ω)

### ◇ RECEIVER

- Receive system : Double-conversion superheterodyne
- Intermediate frequencies :
  - Left band : 1st: 38.85 MHz, 2nd: 450 kHz
  - Right band : 1st: 46.35 MHz, 2nd: 450 kHz
- Sensitivity (amateur bands only):
  - FM (12 dB SINAD) : Less than 0.18 μV
  - DV (BER 1%) : Less than 0.35 μV  
(optional UT-123 is required)
- Squelch sensitivity<sup>†</sup> (threshold) : Less than 0.13 μV
- Selectivity<sup>†</sup> (typical) :
  - Wide : More than 10 kHz/6 dB  
Less than 30 kHz/60 dB
  - Narrow : More than 6 kHz/6 dB  
Less than 20 kHz/60 dB  
DV (optional UT-123 is required) : More than 50 dB
- Spurious and image rejection<sup>†</sup> : More than 60 dB  
\*More than 55 dB for UHF on left band.
- AF output power<sup>†</sup> (at 13.8 V DC) : More than 2.4 W at 10% distortion with an 8 Ω load
- Ext. speaker connectors : 3-conductor 3.5 (d) mm (1/8")/8 Ω

<sup>†</sup>Guaranteed 144–146 or 144–148 MHz and 430–440 or 440–450 MHz ranges only.

All stated specifications are subject to change without notice or obligation.

# 18 SPECIFICATIONS AND OPTIONS

• Sensitivity (for RX bands— FM/AM; for your reference only):

Frequency range	Left band (μV)	Right band (μV)
118–159.995 MHz	0.32/1.0	
160–173.995 MHz	0.56/—	0.56/—
174–179.995 MHz	0.56/—	N/A
180–219.995 MHz	5.6/—	N/A
220–224.995 MHz	0.56/1.8	N/A
225–349.995 MHz	5.6/18	N/A
350–359.995 MHz	0.56/1.8	N/A
360–374.995 MHz	5.6/18	N/A
375–399.995 MHz	0.56/1.8	
400–499.995 MHz	0.32/—	
500–549.995 MHz	0.56/—	
810–879.990 MHz	N/A	0.79 (1.4 for USA)/—
880–999.990 MHz	N/A	1.8 (3.2 for USA)/—

## Options

### CS-2820 CLONING SOFTWARE

Provides quick and easy programming of items, such as memory channels or set mode contents for local repeater frequencies, via a PC's RS-232C terminal using the data communication cable, OPC-1529R, or cloning cable, OPC-478. USB type cloning cable, OPC-478U, also available.

### HM-133 REMOTE-CONTROL MICROPHONE

Remote control microphone with key backlight. Same as that supplied with the transceiver.

### HM-154 HAND MICROPHONE

### OPC-347/1132 DC POWER CABLES

OPC-347: 7.0 m

OPC-1132: 3.0 m Same as that supplied with the transceiver.

### OPC-440 MIC EXTENSION CABLE

OPC-440: 5.0 m

### OPC-441 SPEAKER EXTENSION CABLE

5.0 m

### OPC-474 CLONING CABLE

Used for data cloning between transceivers.

### OPC-478/478U CLONING CABLE

Used for data cloning between transceiver and PC with CS-2820.

### OPC-1529R DATA COMMUNICATION CABLE

Allows low-speed data communication in DV mode and data cloning operation with CS-2820.

### OPC-1663 SEPARATION CABLE

For separate installation. Same as that supplied with the transceiver. 3.4 m

**OPC-1712** CONTROLLER CABLE

For single body installation. Same as that supplied with the transceiver. 10 cm

**SP-10** EXTERNAL SPEAKERS

For all-round mobile operation. Cable length: 1.5 m

**UT-123** DIGITAL/GPS UNIT

Allows to digital voice mode operation. GPS receiver is included for GPS and GPS-A operation. A GPS antenna is supplied with the unit.

**MB-65** MOUNTING BASE

Mounts the remote controller on to variety of place in vehicle. Remote controller bracket is required for mounting.









**Count on us!**

A-6568H-1EX-③  
Printed in Japan  
© 2007 Icom Inc.

Printed on recycled paper with soy ink.

**Icom Inc.**

1-1-32 Kamiminami, Hirano-ku, Osaka 547-0003, Japan